

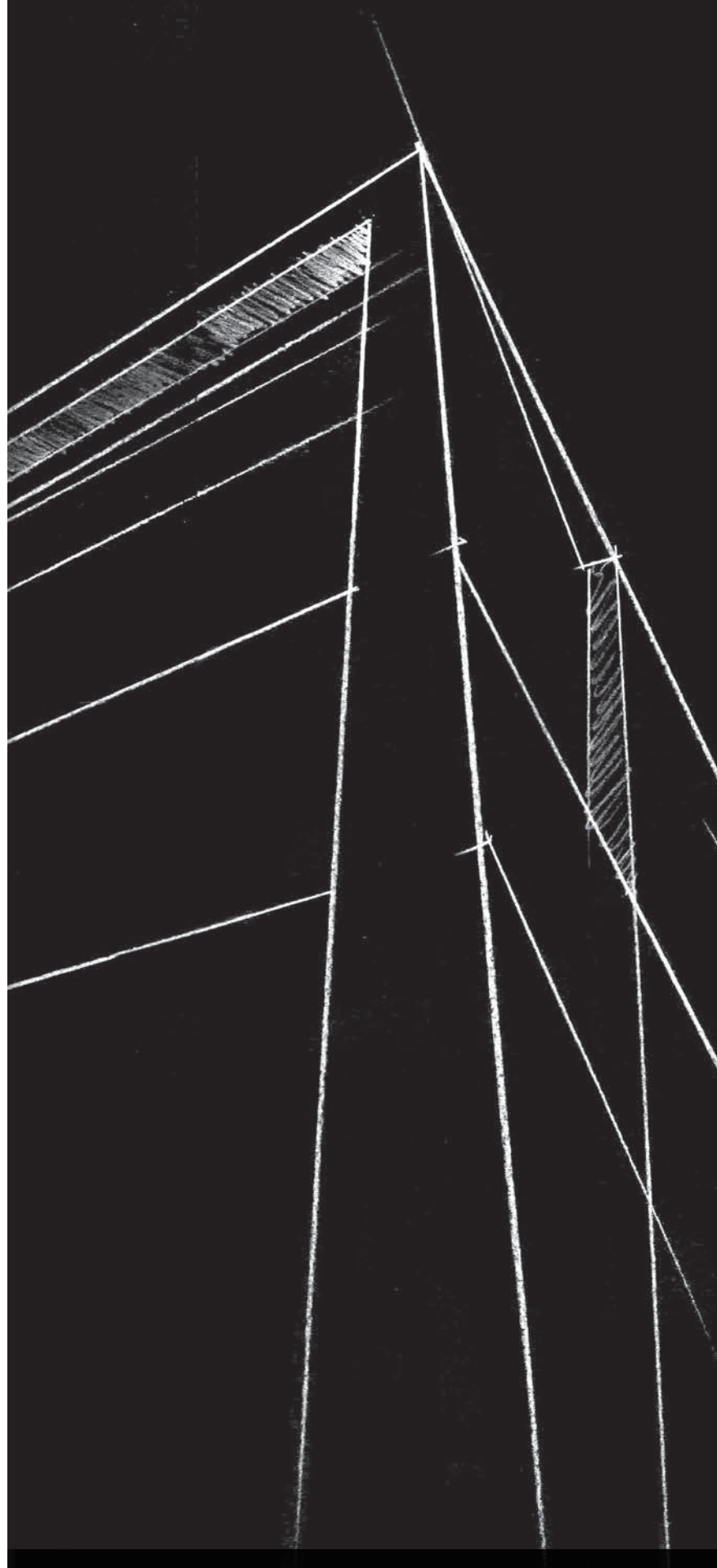

NEOLITH
skyline.

FAÇADES
APPLICATION
TECHNICAL
GUIDE



FAÇADES APPLICATION TECHNICAL GUIDE

INDEX

Neolith general information

Formats and Thicknesses

Color Range

Product Features

- 1.1 Product Certificates
- 1.2 Environmental sustainability. *Green Facts*
- 1.3 Technical Databases
- 1.4 Safety Databases

Transport

Storage

Handling

- 4.1 Cutting Recommendations
- 4.2 Polish
- 4.3 Drilling

Cleaning and Maintenance

- 5.1 Cleaning and Maintenance
- 5.2 Repair

Removal Information

- 6.1 Waste management information

Neolith Installation Systems

General Information

- 1.1 Ventilated chamber
- 1.2 Expansion joints
- 1.3 Substructure

Neolith Attachment Systems

- 2.1 HC System
- 2.2 VM System
- 2.3 Strongfix System

Construction Details

Projects

FORMATS AND THICKNESSES



3.600x1.200 mm / 142"x48"
* Only in 3 and 6 mm (1/8" and 1/4")

3.200x1.600 mm / 125"x64"
* Only in 12 and 20 mm (1/2" and 3/4")

3.200x1.500 mm / 125"x60"
* Only in 6 mm (1/4")

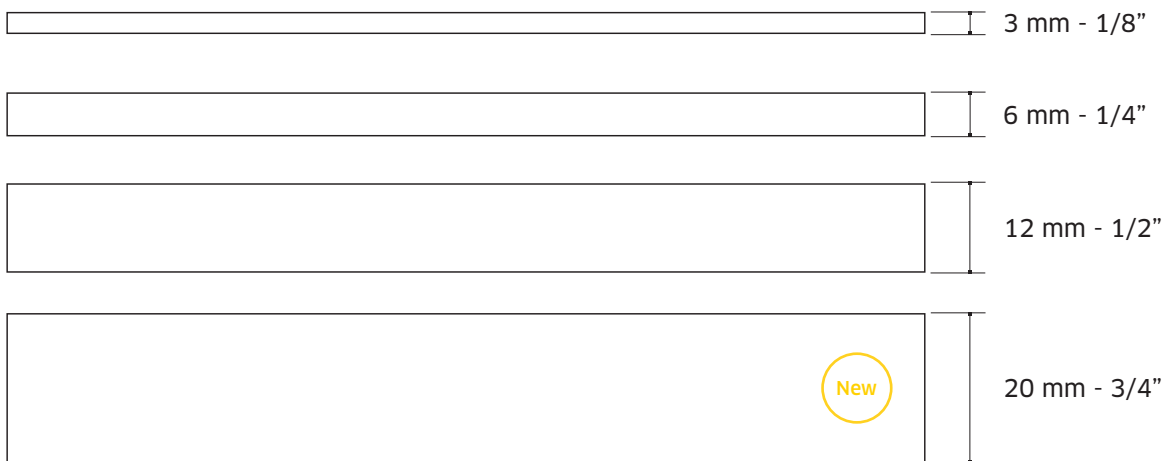

3 mm - 1/8"

6 mm - 1/4"

12 mm - 1/2"

20 mm - 3/4"

New

GENERAL REVIEW

		3200x1600 mm				3200x1500 mm				3600 x 1200 mm			
		12 and 20 mm				6 mm				3 and 6 mm			
		Finishes available											
Collection	Color	Satin	Polished	Silk	Riverw.	Satin	Polished	Silk	Riverw.	Satin	Polished	Silk	Riverw.
COLORFIEL	Arctic White	12	12	20/12		6	6	6		6/3			
	Avorio	12				6				6/3			
	Humo									6/3			
	Nero	12		12		6		6		6/3			
	Nieve	12		12	12	6		6		6/3			
	Perla									6/3			
FUSION	Arena	12				6				6/3			
	Aspen Grey			12				6					
	Barro	12				6				6/3			
	Basalt Beige					6				6/3			
	Basalt Black	20/12		12		6		6		6/3			
	Basalt Grey	12		12		6		6		6/3			
	Beton			20/12	12			6	6				3
	Cement	12				6				6/3			
	Concrete Taupe			12				6					
	Lava					6				6/3			
	Nero Zimbabwe				12				6				
	Phedra	12				6				6/3			
	Pierre Bleue			20/12				6					3
	Pietra di Luna			12	12			6	6				
	Pietra di Osso			12	12			6	6				
	Pietra di Piombo			12				6					
Zaha Stone			12				6						
IRON	Iron Ash					6							
	Iron Copper	12				6				6/3			
	Iron Corten	12				6				6/3			
	Iron Frost	12				6				3			
	Iron Grey	12				6				6/3			
	Iron Moss	12				6				6/3			
TEXTIL	Textil White					6				6/3			
TIMBER	La Bohème B01/B02	12 NH				6 NH							
CLASSTONE	Blanco Carrara BC01/BC02/R		12	12			6	6					
	Calacatta C01/C01R		12	20/12			6	6					3
	Calacatta Gold CG01/CG01-R		12	12			6	6					3
	Estuario E01/E01R		12	12			6	6					3
	Estuario E04/E04R		12	12			6	6					
	Estuario E05/E05R		12	12			6	6					
	Marfil							6					
	Nero Marquina NM01/NM01R		12	12			6	6					
	Onyx translucent							8					
	Onyx O01/O01-R							6					
	Pulpis		12	12				6	6				3
	Strata Argentum				12					6			3
Travertino Navona							6	6					
STEEL	Steel Marengo			12 SS				6 SS					

PRODUCT FEATURES

Neolith is the largest sintered stone available in the market. It is 100% natural product composed of feldspar, silica, clay and other natural minerals and it emulates what nature takes millennia to produce in just a few hours, through an exclusive and highly technological sintering process. Neolith offers the most efficient solutions for the most demanding architectural projects, as well as an extensive combination of colors and finishes, making it a designer product that can be used in numerous applications for interiors, exteriors and furnishings.

Neolith possesses excellent physical properties, making it well suited for use on exterior application. Furthermore, its colors, made of 100% natural pigments, allow it to remain unfaded over the passage of time.

Technical Features:



Lightweight: The thickness of the slabs makes it a very light product and thus facilitates transportation and handling and reduces the load factor on cladding. 7kg/m² for the 3mm option.

FORMAT (in)	3600 x 1200		3200 x 1500		3200 x 1600		
THICKNESS (mm)	3	3+	6	6+	6+	12	20
kg/m ²	7	8	14	15	14	29	48
Full Slab Weight (kg)	34	38	67	72	77	148	245

Table I: Formats and Weights



Waterproof: The Neolith sintering process produces the slabs less than 0,08% porosity. It does not absorb any water and it is resistant to stains, making it ideal for wet locations.



UV Resistance: Being 100% natural, its colors do not fade away when being exposed to sun light or other extreme weather conditions.



Resistant to High temperatures: It does not burn in contact with fire nor does it emit smoke or toxic substances when being subjected to high temperatures



Resistance to wear and tear: Its hard surface makes it resistant to scratches and abrasion when being exposed to extreme weather conditions (such as sand storms or other similar aggressions).



Bending resistance: It has a high shear rate, making it resistant to heavy loads and pressure as well as suitable for some curved applications.



Environmental-friendly: Composed entirely of natural material, completely recyclable. Up to 52% of recycled content. Greenguard, CE, NSF1 certifications. Its use in buildings grants LEED points to the project.



Easy To Clean: Resistant to any kind of chemical cleaning agent such as bleach or ammonia. When used in exterior cladding, this characteristic proves of high-added-value in areas with high pollution levels and risk of graffiti criminality.



Hygienic: Given its practically non-porosity, it does not allow any bacteria or fungus which may lead to allergies or illnesses.

1.1. PRODUCT CERTIFICATES

Neolith is the outcome of a high-tech sintering production process, which meets the highest standards in terms of technological development and energy sustainability. Thanks to the technical features of the product it is suitable for a wide range of interior and exterior applications ranging from commercial to residential projects: façades, flooring, cladding, furnishing, kitchen tops, etc.

TheSize has implanted an ISO 9001 Quality Management System in order to insure product and service excellence to our clients.

Neolith slabs are exposed to rigorous testing process in order to certify the properties and the feasibility to be installed in different architectural solutions, by accredited laboratories. Neolith has been tested by ISO, ASTM and UNE quality standards, as well as other national schemes around the world.

1.2. ENVIRONMENTAL SUSTAINABILITY: GREEN FACTS

TheSize guarantees that the production and lifecycle of its products has the minimum possible impact on the environment, using the cleanest processes and technology to ensure that any waste or emissions generated during the manufacture of the material are kept to an absolute minimum. Any waste from the manufacturing process is properly identified and separated.

Product Composition:



100% Natural: Made of clays, feldspar, silica and natural mineral oxides, Neolith will not emit toxic fumes into the environment when exposed to fire or extremely high temperatures.



100% recyclable: Due to its natural composition, Neolith can be recycled and reduced to its aggregates.



Up to 52% recycled content: Up to 52% of any Neolith slab is composed of recycled natural materials.

Near-Zero Porosity: With a porosity of less than 0.08%, Neolith is impervious to absorption, making it a hygienic product resistant to bacteria that can cause disease and trigger allergies.

Certifications and Memberships:



Greenguard Certification (formerly GREENGUARD Indoor Air Quality Certification): Certifies that Neolith meets strict chemical emissions limits, contributing to a healthier interior.



Greenguard Gold Certification (formerly known as GREENGUARD Children & Schools Certification): Certifies that Neolith is safe indoors for sensitive individuals (such as children and the elderly) and ensures that the product is acceptable for use in environments such as schools and healthcare facilities.



CE (European Commission) Certification: Confirms that Neolith meets European safety, health and environmental protection requirements.



LEED Points Earner: LEED, Leadership in Energy and Environmental Design, is a program that provides third-party verification of green buildings. Neolith satisfies safety prerequisites and earns points to help consumers achieve the desired level of certification for their home or commercial project.



Member of the U.S. Green Building Council (USGBC): The USGBC, the council that oversees LEED, allows advocates for green-building policies and practices to come together.

Neolith's unique sintering process and proprietary design also provide additional green benefits:

- Fewer raw materials, less erosion: Neolith's thin slabs use fewer raw materials, resulting in less soil erosion, without sacrificing any strength.
- CO₂ Emissions Reduction: A slimmer slab means a lighter slab. With Neolith, it's possible to transport more than double the amount of surface per container than with thicker products like marble, granite or quartz. The lighter weight allows for a more fuel efficient journey and considerable reductions in CO₂ emissions.
- No gut remodels: Neolith's slim surface can be applied directly onto existing surfaces, thus saving time and money from tear-outs while reducing landfill waste. No landfill waste means no waste transportation needed, further reducing net CO₂ emissions.
- Optimized energy consumption: Neolith's resistance to extremely high and low temperatures makes it ideal for ventilated façades. The thermal insulation and ventilation between the Neolith façade and the building itself optimizes the building's energy consumption considerably (up to 40%).
- 10 years warranty: Neolith countertops come with a manufacturer's warranty of 10 years and do not need frequent replacement or maintenance treatments like other surface materials.

Neolith gives designers, architects and other industry professionals confidence that their aesthetically-appealing design decisions are equally appealing to the environment.

1.3 TECHNICAL DATABASE

Description:

Neolith is the result of cutting edge R&D of architectural surfaces. Natural raw materials are carefully selected and transformed by a proprietary sintering process which applies very high pressures and temperatures (over 2,192 °F), leading to a physically and mechanically high-performing product. Its light weight provides considerable savings during installation.



Image 1: TheSize Surfaces facilities in Almazora. Picture: May 2016

Applications:

Thanks to its excellent properties, Neolith is resistant to changing weather conditions and fade resistant to UV radiation exposure. It adapts to multiple purposes and can be applied to exterior and interior residential and commercial projects. Its uses include but are not limited to: Ventilated façades, flooring, cladding, kitchen countertops, vanities, furniture, swimming pool claddings, etc...

Certificates:

Neolith has been extensively tested and independently verified to meet and surpass standards with regards to pollutant emission levels. Furthermore, Neolith has been granted the certificated “Greenguard for Children & Schools”, which ensures maximum safety for use in schools and hospitals.

Neolith supports architects and designers to maintain the beauty and aesthetics of a building complementing it with safety and performing properties. Furthermore, Neolith assists in earning LEED points in a project given that it has high recycled content (from 35 to 52%).

PROPERTY	TEST METHOD	3600 x 1200		3200 x 1500	
		3	3+	6+	12
THICKNESS (mm)		3	3+	6+	12
WEIGHT (lb)	-	71	80	187	315
BREAKING STRENGTH, AVER. (N)	ISO 10545-4	32	36	85	143
BREAKING STRENGTH, AVER. (N)	ASTM C648-04	299	991	C.S.*	C.S.*
MODULUS OF RUPTURE, AVER. (N/mm ²)	ISO 10545-4	48	54	57	57
WATER ABSORPTION	ASTM C373-88	0.2%			
IMPACT RESISTANCE, AVER.	ISO 10545-5	0,8 ⁽¹⁾			
RESISTANCE TO DEEP ABRASION	ISO 10545-6	<133 mm ³			
THERMAL LINEAR EXPANSION	ISO 10545-8	5,2 - 6,3.10 ⁻⁶ °C ⁻¹			
RESISTANCE TO THERMAL SHOCK	ISO 10545-9	No visible defects			
MOISTURE EXPANSION	ASTM C370-88	0.2%			
FROST RESISTANCE	ASTM C1026-10	No visible defects			
CHEMICAL RESISTANCE	ASTM C650-04	Not affected			
STAIN RESISTANCE	ISO 10545-14	Class 5			
LEAD AND CADMIUM GIVEN OFF BY TILES	ISO 10545-15	Lead: <0,01 mg . dm ⁻² Cadmium: <0,001 mg . dm ⁻²			
HARDNESS (MOHS)	UNE 67-101	>6			
ANTI SLIP PROPERTY ⁽²⁾	DIN 51330	R9			
STATIC FRICTION COEFFICIENT ⁽²⁾	ASTM C1028-07	Dry 0,76 - 0,94 Wet 0,43 - 0,67			
REACTION TO FIRE	DIN EN 13823	Neolith: A1 Neolith+: A2-s1, d0			
UV RESISTANCE	DIN 51094	No Alteration			

(*) Coming Soon

(1) Pavement requirement, not applicable to Neolith 3 mm, 3+, 3+3

(2) Anti-slip properties can be adjusted on request

Table 2: Neolith Test Results

1.4 SAFETY DATABASE

From all the available information about Neolith, The Size has prepared a Safety Data Sheet as specified in the REACH Regulation (EC) N° 1907/2006.

The purpose of this guide is to provide employees general information and guidance on how to handle the product during all activities, to promote and improve working conditions and to minimize potential risks through the implementation of the risk management measures proposed in this document.

Because of the product characteristics, employees should be aware that during cutting and/or polishing of Neolith, they may come in contact with breathable airborne crystalline silica (quartz). Prolonged or massive inhalation of breathable crystalline silica may cause pulmonary fibrosis, commonly known as silicosis. The main symptoms include coughing and difficulty breathing. Therefore TheSize recommends wet cutting and polishing to reduce the exposure to breathable crystalline silica dust to a minimum.

According to Regulation (EC) N° 1907/2006 Version 2 Print date 21.12.2011 Revision date 21.12.2012, the finished product (porcelain tile) presents no risk to human health and the environment. Because of generation of silica dust in the dry manipulation processes the following risks must be taken into account:



Regulation CLP CE N° 1272/2008 Crystalline silica dust	Classification according Directive 1999/45/CE
<p>Precautionary statements</p> 	
<p>P260: Do not breathe dust generated in the cutting, shaping and polishing of the material.</p> <p>P264: Wash hands and face thoroughly after handling</p> <p>P270: Do not eat, drink or smoke when manipulating</p> <p>P280: Wear gloves, suitable work clothing and goggles</p> <p>P284: Wear respiratory protection for particles (P3)</p> <p>P314: Consult doctor if feeling unwell</p> <p>P501 Remove residues in accordance with local regulations</p>	<p>R20: Harmful by inhalation</p> <p>R48: Danger of serious damage to health by prolonged exposure</p> <p>S22: Do not breathe dust</p> <p>S38: In case of insufficient ventilation wear suitable respiratory equipment (P3)</p>

Table 3: Safety Guidelines

Additional Information:

According to information provided, the testing of the product has not detected or cristobalite or tridymite, which are the more siliceous and dangerous varieties.

More detailed information regarding safety and health standards and recommendations is available on www.neolith.com (Downloads: Safety Data Sheets section).

Neolith slabs must be transported in metal or wooden racks and always in vertical position. The slabs should be correctly fixed to the rack to prevent the movement of the material. The panels must never be transported loose or with broken straps. For short distance, inside workshops or at the construction site, fasten the panels using straps with cardboard protection.



Image 2: A-Frame transportation

In order to unload and move loaded A-frames around, a forklift capable of lifting and moving these A-frames will be required

A fully loaded A-frame of slabs weighs around 3600 kg. The forklift must be capable of lifting this weight on the tip of its forks.

A metallic A-frame has a maximum loading capacity of 3600 kg and mixed A-frame 3000 kg. The following table shows the maximum amount of slabs allowed on a single A-frame.

	3+	6+	12
Metallic A-Frame 3.800x1.400	90	-	-
Metallic A-Frame 3.300x1.800	-	44	24
Mixed A-Frame 3.800x1.400	90	-	-
Mixed A-Frame 3.300x1.800	-	34	20

Table 4. Slab units per A-Frame

STORAGE

Slabs must be stored in vertical position. It is essential to avoid resting them on objects or debris that prevents the panels from being completely in vertical position.

The optimal condition of storage will be in clean and dry place protected from weather conditions. TheSize recommends storage of Neolith slabs in ambient temperature and humidity conditions and keeping the material in its original packing. There are no limits in terms of storage life times. Wooden support beams are recommended to avoid chipping of the slabs.



Image 3: Vertical storage in A-Frames



Image 4: 12 mm slabs vertical storage



Image 5: Wooden supports beams

HANDLING

Handling and moving slabs should only be undertaken by trained personnel using the correct equipment. Handling of the slabs should be done in a vertical and straight position to prevent the slab from bending.

Due to the possible presence of sharp edges, protective gloves should be always worn when handling Neolith slabs.

Product can be handled within location via clamps (when thickness of slab exceeds 5 mm), with aluminum frames with suction cups and manually.



Image 6: Alimunium frame with suction cups



Image 7: Slab handling with Suction Frame



Image 8: Proper manual handling position



Image 9: Clamp handling for 12 mm slabs

For more detailed information about product handling please refer to our website (Downloads - Technical Manuals).



4.1 CUTTING RECOMMENDATIONS

Cutting of the slabs should only be done by a machining or construction professional with proper equipment. The homogeneous composition of the material makes it possible to machine both sides and the surface. Cutting Neolith slabs is comparable to machining natural stone although a few differences should be taken into account.

Cutting of the slabs can be done with Diamond-tipped discs or other more sophisticated systems such as waterjet or CNC.

To remove any possible stress that the slab may have, TheSize recommends to cut 3 cm of each side of the slab.

For more specific recommendations about cutting Neolith panels, visit www.neolith.com and download the technical manual “Cutting Recommendations”, or watch the specific videos in our website.

4.2 POLISH

Polished edges are fabricated by standard granite/marble polishing discs of different grain sizes.

Start off with the lowest grit and finish with the highest grit, if required the edge can be buffed using polishing wax.

For more details about Polishing Neolith visit www.neolith.com and download technical manual “Fabrication, Tools, Handling and Maintenance of Neolith Countertops”.

4.3 DRILLING

The panel should be drilled by with diamond tipped bits. Supporting sheets (martyr boards) must be used under the panel in order to drill a clean hole, without “breakout”.



Image 10: Fabrication tools

For more detailed information about product handling please refer to our website (Downloads - Technical Manuals).



5.1 CLEANING AND MAINTENANCE

Neolith, being 100% natural and non-porous proves to be a very easy to clean material which requires minimum efforts in terms of maintenance.

Furthermore, Neolith also has another surface with water-and-moisture option to prevent staining and/or external agents from attacking the protection and it easy to clean, making it an ideal material for flooring and cladding.

Periodical cleaning just involves washing with water or a diluted commercial detergent (following the manufacturer's dosage), which is enough to restore the surface to its original condition. Occasionally deeper cleaning may be needed in order to restore the original finish, which include:

First Cleaning

This is the cleaning at the end of the refurbishment/remodeling work: It is the most important step, as it influences the results of the subsequent use of the product. Its goal is to remove all traces of foreign materials and residue from the surface of the slabs.

If you used cement based adhesive for the placement, TheSize recommends the following operations, once the adhesive has dried:

- Remove dirt with a vacuum cleaner;
- Wet the floor with clean water in order to soak and protect the joints against the corrosive action of the detergent;
- Use an appropriate acid detergent (descaling agents or cement remover) to clean. The detergent has to be diluted in water and the user instructions must be followed while addressing the precautions for safe use (e.g. gloves, adequate ventilation, ...);
- Absorb the solution with a clean cloth or a suitable vacuum cleaner;
- Thoroughly rinse the entire surface with clean, warm water to neutralize the action of the detergent
- Remove any buildup by scraping it off;
- If necessary, clean the surface again using a diluted neutral or alkaline detergent, then rinse with clean warm water and dry the surface.

If an epoxy sealant has been used for the placement, any remaining residue on the slab's surface should be removed before the grout has hardened completely and carefully follow the instructions supplied by the manufacturer.

Warning

- *Some of the components of the adhesives are sensitive to acids. For this reason, it is recommended to ask the manufacturer for guidance on the most suitable detergent for cleaning.*
- *In cases of particularly difficult stains, perform a localized cleaning following the indications given in the table type detergent according to the type of dirt, which is at the end of this document. With particularly difficult stains, clean the area by following the instructions in the table Detergents types according to type of dirt, included at the end of this chapter.*

Everyday cleaning

For cleaning dirt in general, it is advisable to vacuum or sweep the surface and then wipe with a cleaning solution using a detergent in a concentration recommended by the manufacturer. (Avoid products containing hydrofluoric acid and its derivatives)

It not advisable to use waxes, oily soaps, impregnating agents or other treatments (hydro-oil repellent) on the product, because its application is not necessary at all. Some of the detergents currently on the market contain waxes or polishing additives that, after several washes, can leave an oily film on the surface of Neolith.

Special maintenance

This is an intense and thorough cleaning that may be required annually or semiannually. It is done with the same methods as for the everyday cleaning, but using a medium concentration of alkaline detergents.

5.2 REPAIR

Sintered compact surfaces can be damaged by a variety of reasons. Most often due to collision or impacts produced by a heavy object.

The operation procedure consists of cleaning the surface with acetone or dissolvent and then repairing the chip with a double component glue or mixed pigment to prepare the same color as Neolith slabs. After, the double component glue would be applied to refill the chip. Finally dry polishing will be needed in order to match the rest of the surface design. For more detailed instructions, please visit www.neolith.com and download the "Repairing Neolith Surface Defects" Guide.



Image 11: Coffe stain on Arctic White countertop

Neolith slabs have amongst other application possibilities, the ventilated façade application where they are used together with other components such as aluminum, steel etc. Neolith slabs can be easily extracted and removed from ventilated façades.

6.1 WASTE MANAGEMENT INFORMATION

Regulations and laws concerning the production and management of waste generated in construction and demolition vary from country to country. Constructors must ensure they are aware of local regulations with regards to this matter and must always fulfill them.

TheSize encourages the reuse of Neolith slabs in other applications when possible.

FAÇADES
APPLICATION
TECHNICAL
GUIDE

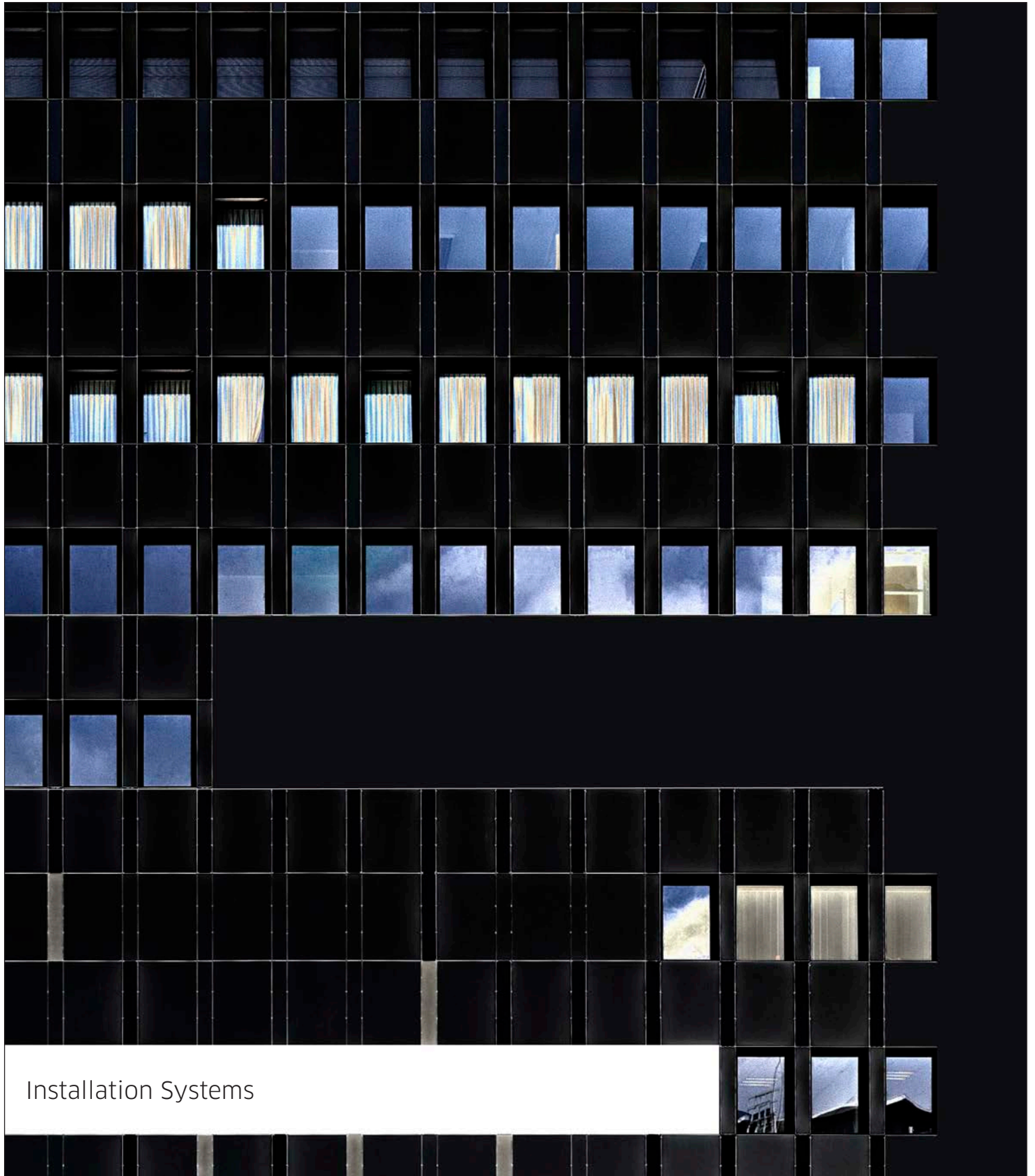

Installation Systems

Neolith is a high quality construction material with a wide range of installations applications such as coating for ventilated façades solutions.

Neolith has the best physical and mechanical properties to fulfill the most demanding ventilated façade requirements, granting an extraordinary added value to an architectural solution.

1.1. VENTILATED CHAMBER

Neolith slabs installed as a ventilated façades must be separated from building's wall by a composition of profiles. Generally speaking, chambers have a minimum size of 30 mm and are not limited to any maximum size. To allow air circulation between the ventilated façade and the building's wall it is necessary to correctly dimension the opening of the façade.

Coronation & Base ventilation

The dimension of the opening on the coronation and on the bottom areas of the façade should be at least of 20mm. This measure allows for correct air flows which optimize the properties of ventilated façades towards a building.

Subdividing the chamber

In the case country and regional building codes require vertically-oriented division of the ventilation chamber in order to prevent any possible spread of flame in the event of a fire; a possible solution would be to create ventilated compartments approximately every 6 meters to prevent the propagation. It is always recommended to use fire-proof materials.

Advantages of the Ventilated Façades

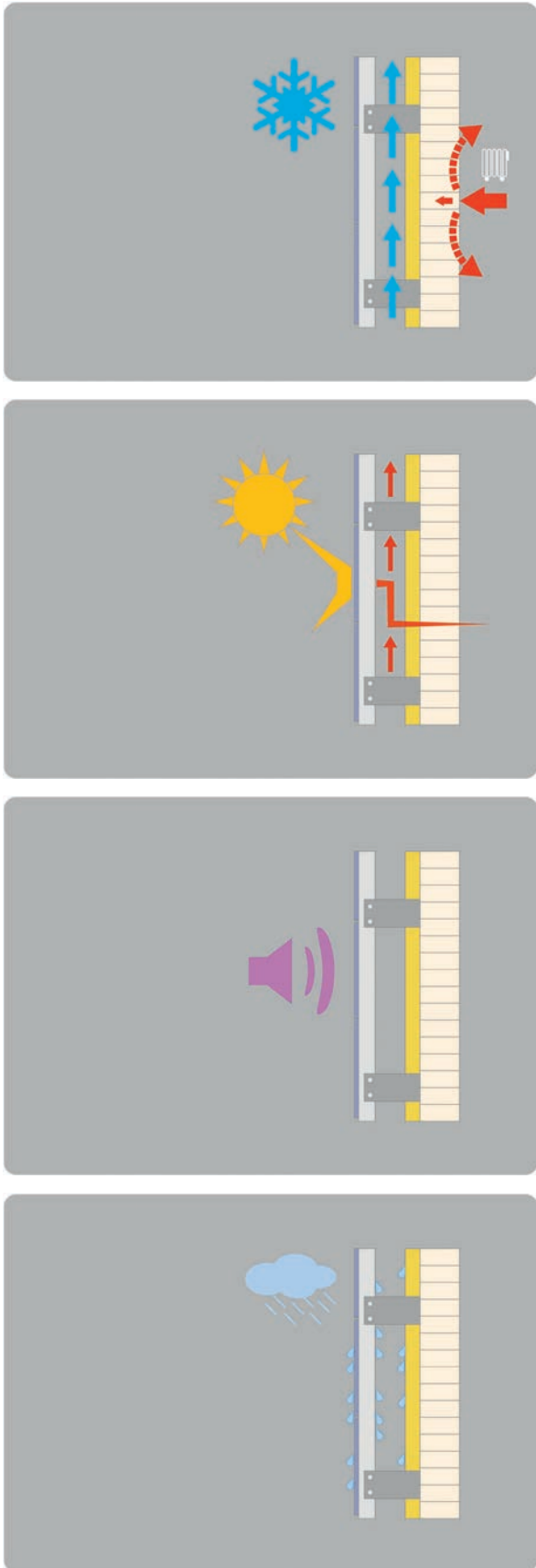

Image 12: Ventiladed façades properties

Permeability

Moving air diffuses water vapor from the inside out and facilitates the “breathing” of the façade, preventing condensation from forming behind the slabs.

Thermal insulation

Insulation applied on the external structure eliminates the thermal bridges thus reducing temperature fluctuations inside building, leading to energy savings in some cases, up to 40%.

Solar Protection

Thermal comfort is provided inside the building by preventing overheating in the summer and therefore protecting the building from direct radiations and from other elements.

Acoustic Insulation

Given that the ventilated façade system is composed of different layers, there is an increase in the level of noise absorption taken by the different elements.

Water Impermeability

Chimney effect provided by the air chamber confers an extra protection due to the air pressure, preventing water infiltration and protecting the building structure.

1.2. EXPANSION JOINTS

Neolith installation process should leave expansion joints around the perimeter of the panels for free deformation. Because of the extraordinary properties of thermal expansion, the space between panels should be at least 1/8".

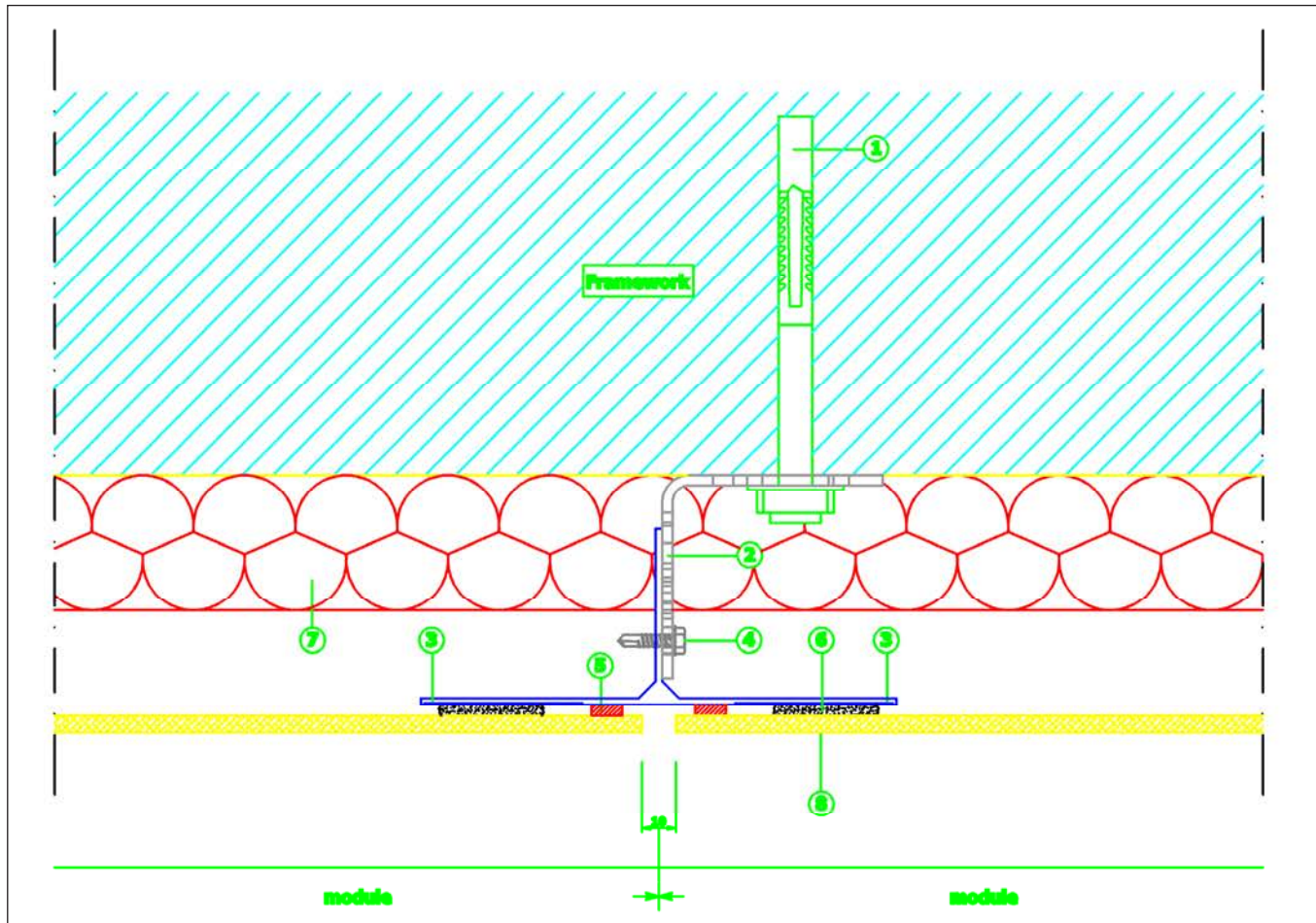
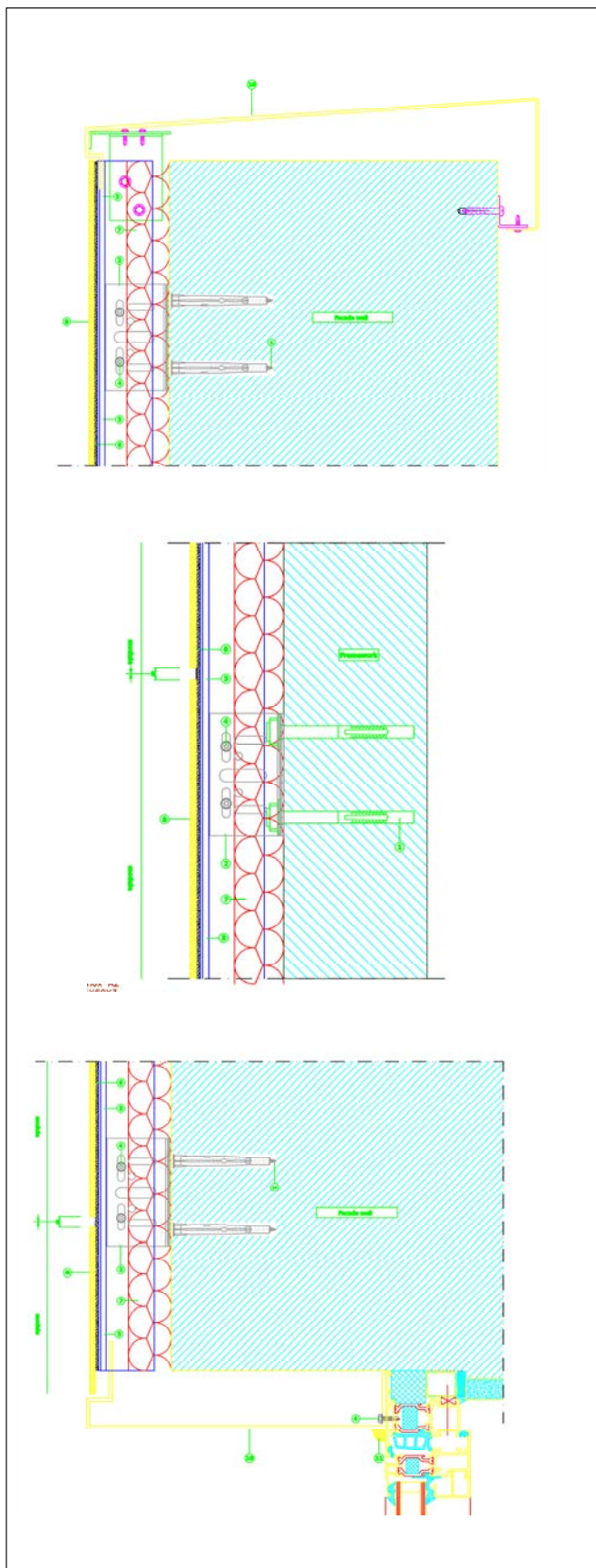

Image 13: Expansion joint on HC System

- 1.-Bracket MTA 10x90 inox A2
- 2.-ESC aluminum 100x65x60x3
- 3.-Vertical aluminum profile "T 100x50x2"
- 4.-Screw DIN 7504-K 6.3x25 inox A2
- 5.-Double side tape
- 5.-Adhesive PanelTack-HM
- 6.-Insulation
- 7.-Neolith Slab



- 1.-Bracket MTA 10x90 inox A2
- 2.-ESC aluminum 100x65x60x3
- 3.-Vertical aluminum profile "T 100x50x2"
- 4.-Screw DIN 7504-K 6.3x25 inox A2
- 5.-Double side tape
- 5.-Adhesive PanelTack-HM
- 6.-Insulation
- 7.-Neolith Slab

Image 14: HC General elevation section

1.3. SUBSTRUCTURE

With the aim of facilitating air circulation behind the slabs, a substructure of vertical profiles must be installed. This substructure must be designed according to the building codes and wind pressure requirements relative to each market. It is also important to consider the inclination of the façade, the fastening system chosen and the dimension of Neolith panels being installed. Furthermore, protection against corrosion and rotting must be considered regardless of the material or system being employed.

Wood Substructure

If the substructure is built from timber battens, they must be suitably treated. It is recommended to install PVC joints or closed-cell polyethylene foam over the exposed surfaces, as these protect, improve and extend their life span. This type of substructure may be used only in dry areas with scarcity of rainfall.

Metal Substructure

If located in rainy areas or areas with a high degree of humidity, it is preferable to use metal profiles made by aluminum. In areas suffering the obvious effects from the sea, it is highly recommended to use anodize aluminum profiles.

2.1. HC FIXING SYSTEM

Hidden Fixing with Longitudinal Adhesion

This option developed for Neolith cladding, consists of a hidden support system using chemical elastic longitudinal fixation mounting on vertically “T”-shaped or “L”-shaped profiles, depending on whether the profiles match the joints between Neolith slabs or if they are reinforcing the center of the joint and supporting the bearing through retention or sustentation brackets.

The whole system has been tested in laboratories certified for such a fact, the results having been found satisfactory for the use of Neolith and can be found later on in this manual.

System Properties

TheSize recommends the use of last generation, chemical elastic adhesives, especially developed for fixing and anchoring Neolith slabs (Please, refer to Table 4 below). These must have great vibration damping capacity and structural adhesion without using any rivets or screws. The chemical-elastic anchoring systems have a number of accessories for its proper installation.

- Double-sided tape for initial fastening of Neolith until full curing of the adhesive and the optimum spacing for the adhesive strength.
- Primer for the proper cleaning of the aluminum profile and the backside of Neolith, providing better adhesion.

Brand	Product
Sika	Sikatack
Quilosa	FixPaneles
Botik	Paneltack
Dow Corning	896 PanelFix

Table 4: Recommended Chemical-elastic Adhesives

HC System description

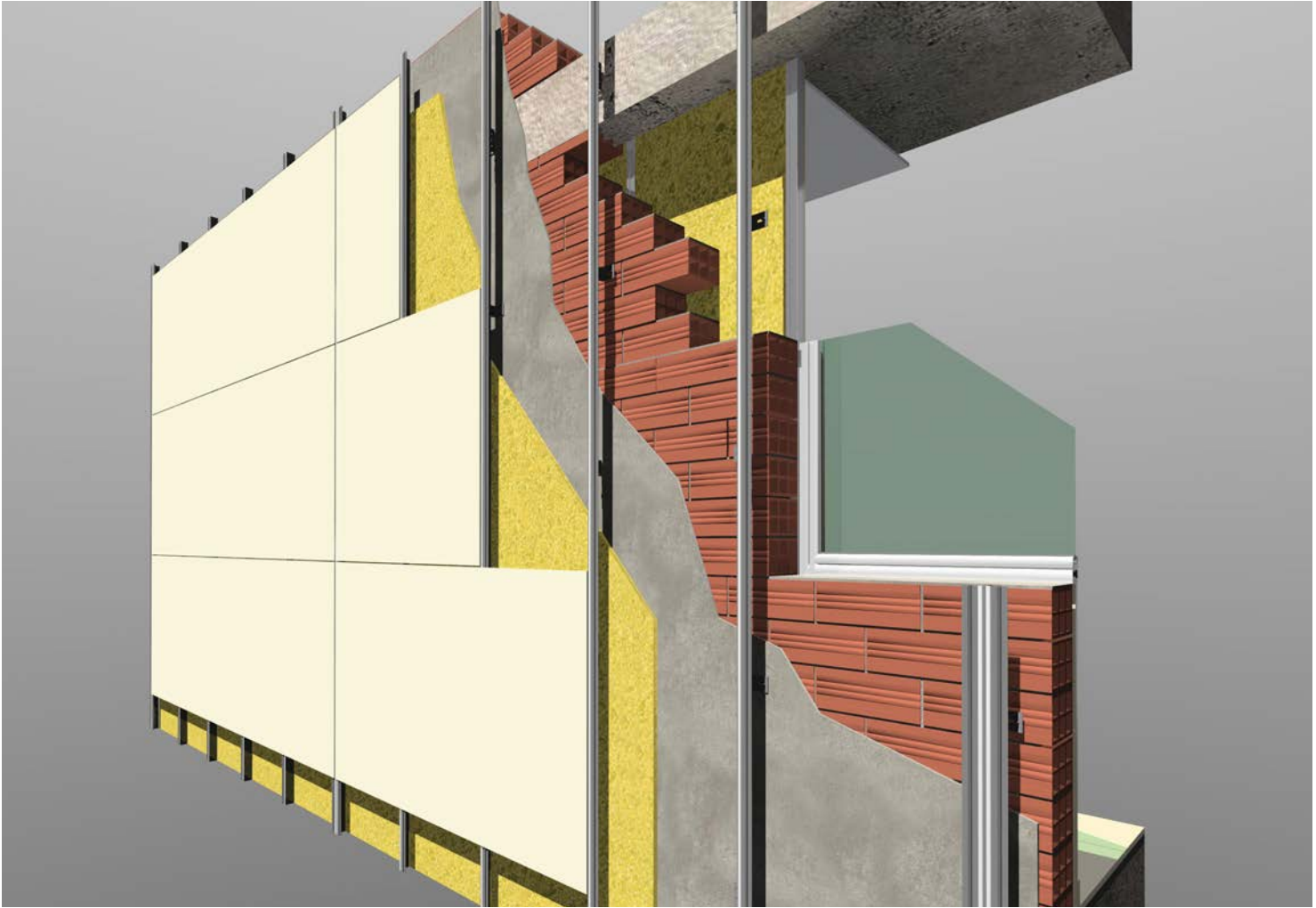

Image 15: HC System mockup

- 1.-Thermal Insulation
- 2.-ESC aluminum 100x65x60x3
- 3.-Vertical aluminum profile "T 100x50x2"
- 4.-Adhesive PanelTack-HM
- 5.-Double side tape adhesive
- 6.-Neolith Slab

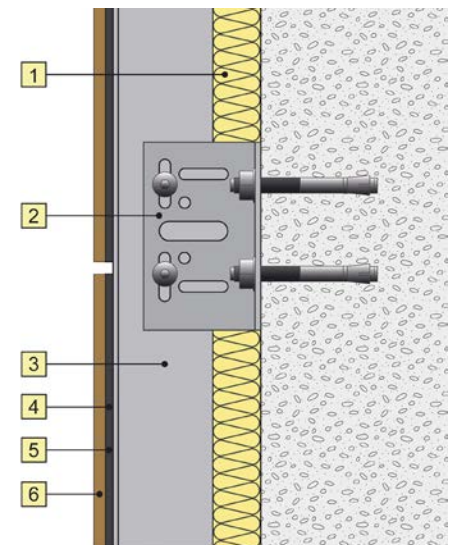

Image 16: HC System vertical section

Advantages of Chemical Elastic Fixation:

- Diffuse binding stresses uniformly without forming critical points where breakage could start.
- Avoid stress concentration at the adhesion surface.
- Achieve a hidden fixing system without aesthetic distortions.
- Avoid galvanic corrosion by electrical insulation and separate those materials likely to suffer from it.
- Reduce or eliminate the transmission of vibrations between the bonded materials.
- Avoid bond failure by fatigue.
- Enable the joining of different type of materials.
- Improve the aesthetics of the joints

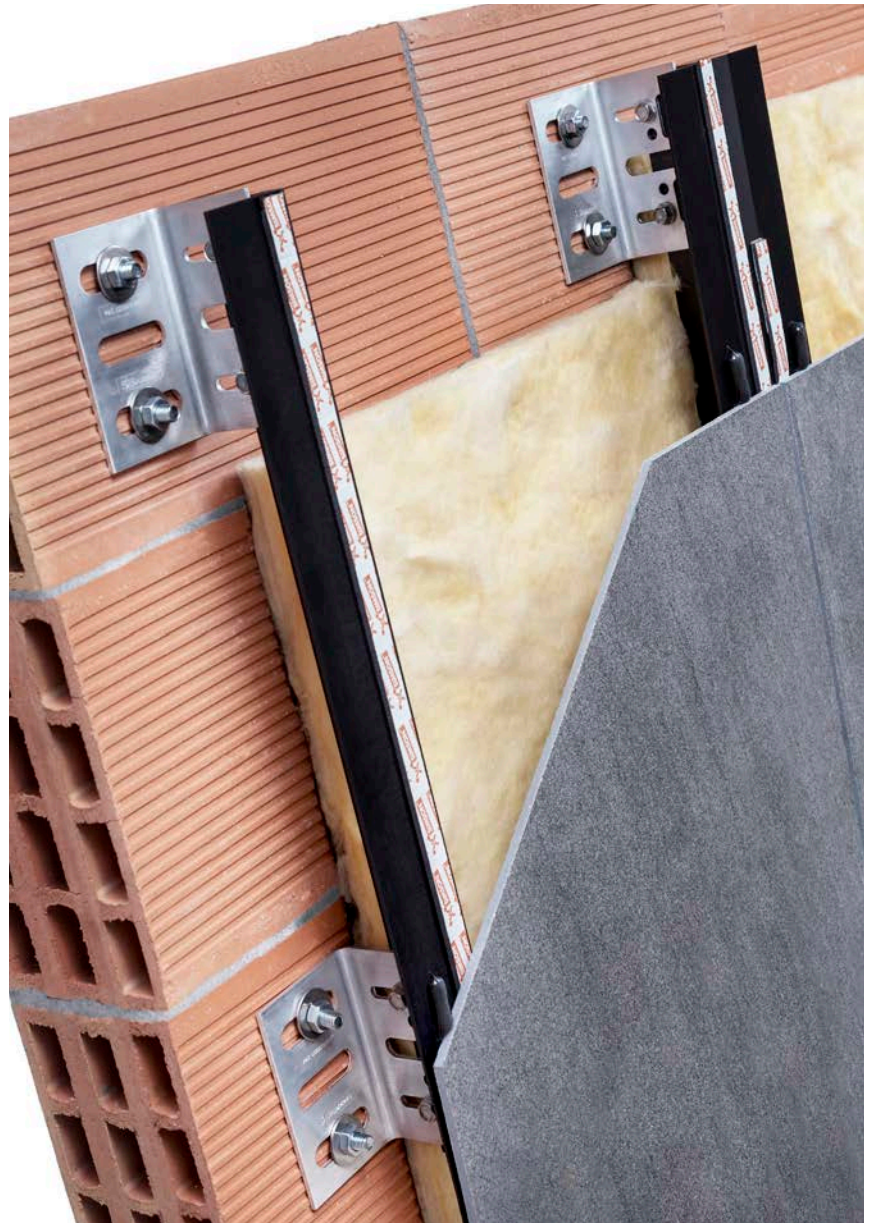

Image 17. HC System detail



Image 18. HC System details



Image 19: HC System installation Step 1



Image 20: HC System installation Step 2

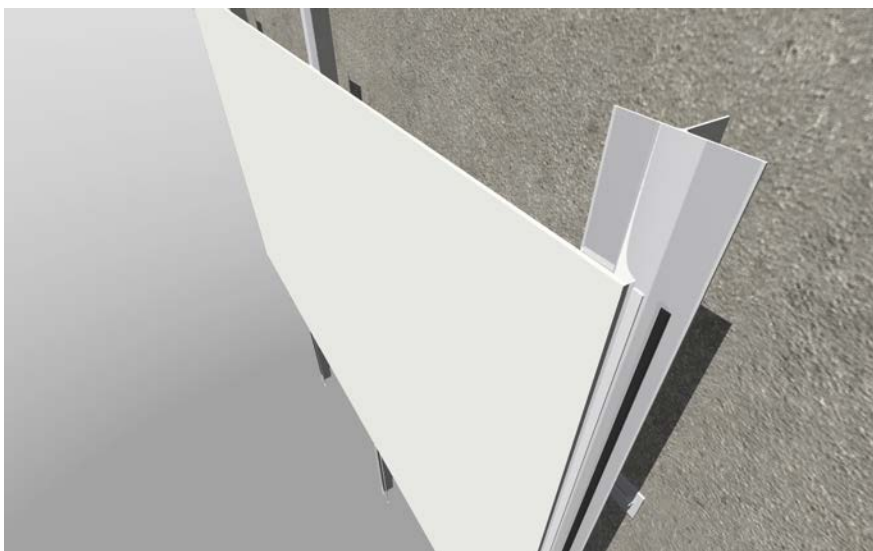

Image 21: HC System installation Step 3

Substructure distribution and installation:

Dimensions of the perpendicular substructure depends on the façade construction. The distances between the substructure battens and their width are determined by the load requirements and by the type of panel used.

Application Method:

Clean the surface with a clean, grease and fluff free cellulose cloth or cleaning paper soaked, wiping the surface in one direction only (dirty cloths must be replaced).

Apply one thin coat of primer uniformly all over the surface with a brush or felt pad. Allow a flash off time of at least 30 minutes .

The back Neolith surface to be bonded must be clean, dry and free from grease.

Bonding-Tape Application:

Apply Double Side Tape over the whole length of the vertical sections and parallel to the edges.

Do not pull off the protective foil at this time.

Apply Structural Adhesive in a triangular bead by using the triangular nozzle supplied (width 8 mm, height 10 mm) with at least 5 mm gap to the fixing tape and to the side of the batten.

Neolith Panel placing:

Remove the protective foil on the Double Side Tape. Place the cladding panel in the required position on the adhesive bead without the panel touching the fixing tape. To simplify mounting, the panels should be carefully designed. Position the panels precisely and press them firmly until they contact the Structural Adhesive Panel fixing tape.

Component details

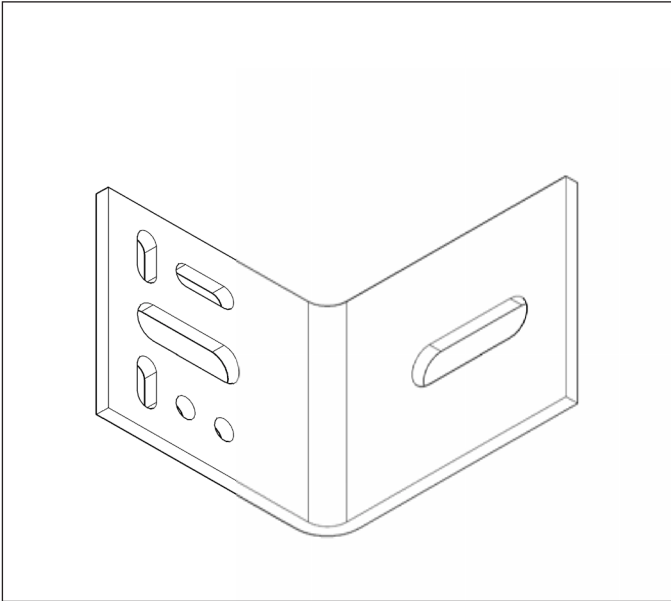

Image 22: Supporting bracket

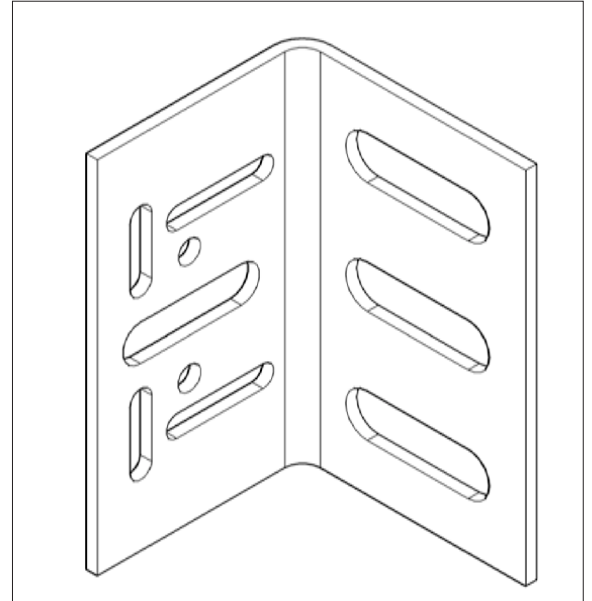

Image 23: Retention bracket

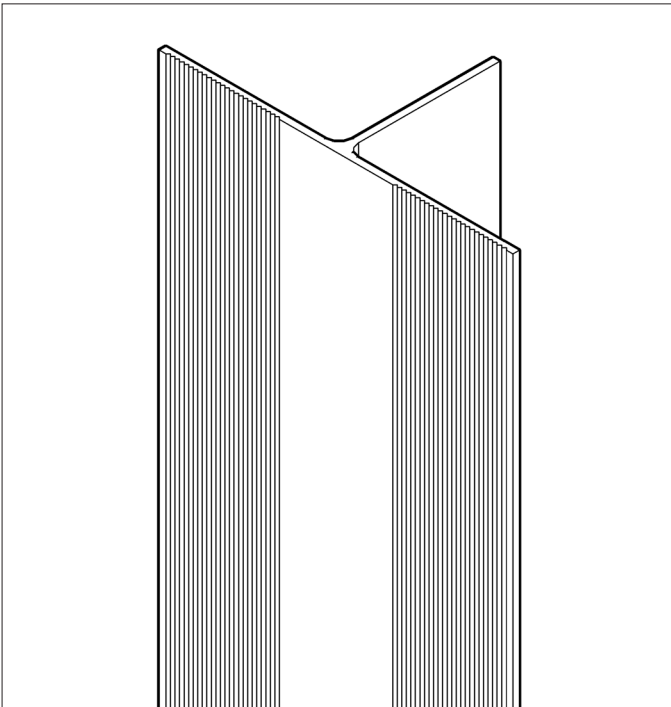

Image 24: Vertical profile

Component details

Components	Materials
Vertical Profile	Al 6063 T5
Brackets	Al 6063 T5
Screws and Fixations	AISI 304/316

Table 5: Component details

Main characteristics of the material

Characteristics Al 6063 T5	
Specific Gravity	2.700 kg/m ³
Coefficient of Thermal Expansion from 20 to 100 °C	23,6 x 10 ⁻⁶ K ⁻¹
Modulus of elasticity	69.500 N/mm ²
Poisson Coefficient	0,33
Tensile Resistance	215 N/mm
Shear Resistance	140 N/mm ²
Yield stress (Rp 0,2%)	160 N/mm
Elongation (L0-mm)	12%
Elongation (L50-mm)	14%
Brinell Hardness	70

Table 6: Al 6063 T5

Characteristics AISI 304	
Specific Gravity	7.930 Kg/m ³
Coefficient of Thermal Expansion from 20 to 100 °C	17,3 x 10 ⁻⁶ K ⁻¹
Modulus of Elasticity	190.000 N/mm ²
Poisson Coefficient	0,33
Tensile Resistance	540-750 N/mm
Yield stress (Rp 0,2%)	≥ 230 N/mm
Elongation (L0-mm)	< 45%
Brinell Hardness	183

Table 7: AISI 304

2.2. VM FIXING SYSTEM

Visible Mechanical Fastening Fixation

This system consists of a metallic self-supporting substructure kit for ventilated façades, designed to support ceramic coatings of different formats and thicknesses. It has been developed for Neolith façades based on a visible mechanical fastening system composed of sustentation and retention brackets, vertical “T” or “L”-shaped profiles and safety clips upon which the cladding system rests.

Flatness of the vertical “T” or “L”-shaped profiles is achieved thanks to the supporting and retention brackets or spacers. Complete flatness will depend on whether the profiles match exactly the joints between the slabs, correcting possible deviations on the interior layer of the façade to cladding.

The clamps responsible for sustaining the structure described above are located on Neolith slab as well as on a grooved area for the application of adhesive, granting greater security to the system.

System properties

The system is composed of retention and support angle brackets, vertical profiles and staples to support the cladding. Thanks to the angle brackets (support/retention) it is possible to ensure a proper leveling of the vertical profiles, correcting likely deviations from the original facade that is going to be covered. To ensure the dimensional stability of the system, an elastic adhesive line is applied along the T-shaped vertical profile. This elastic adhesive ensures the correct fitting of the pieces, improving the system response against wind pressure or suction and gravity loads. Possible vibrations produced by these efforts are also absorbed by this adhesive.

Finally, the staples are fixed to the vertical profile using stainless steel self-drilling screws and allows Neolith pieces to be quickly and easily replaced.

VM System description

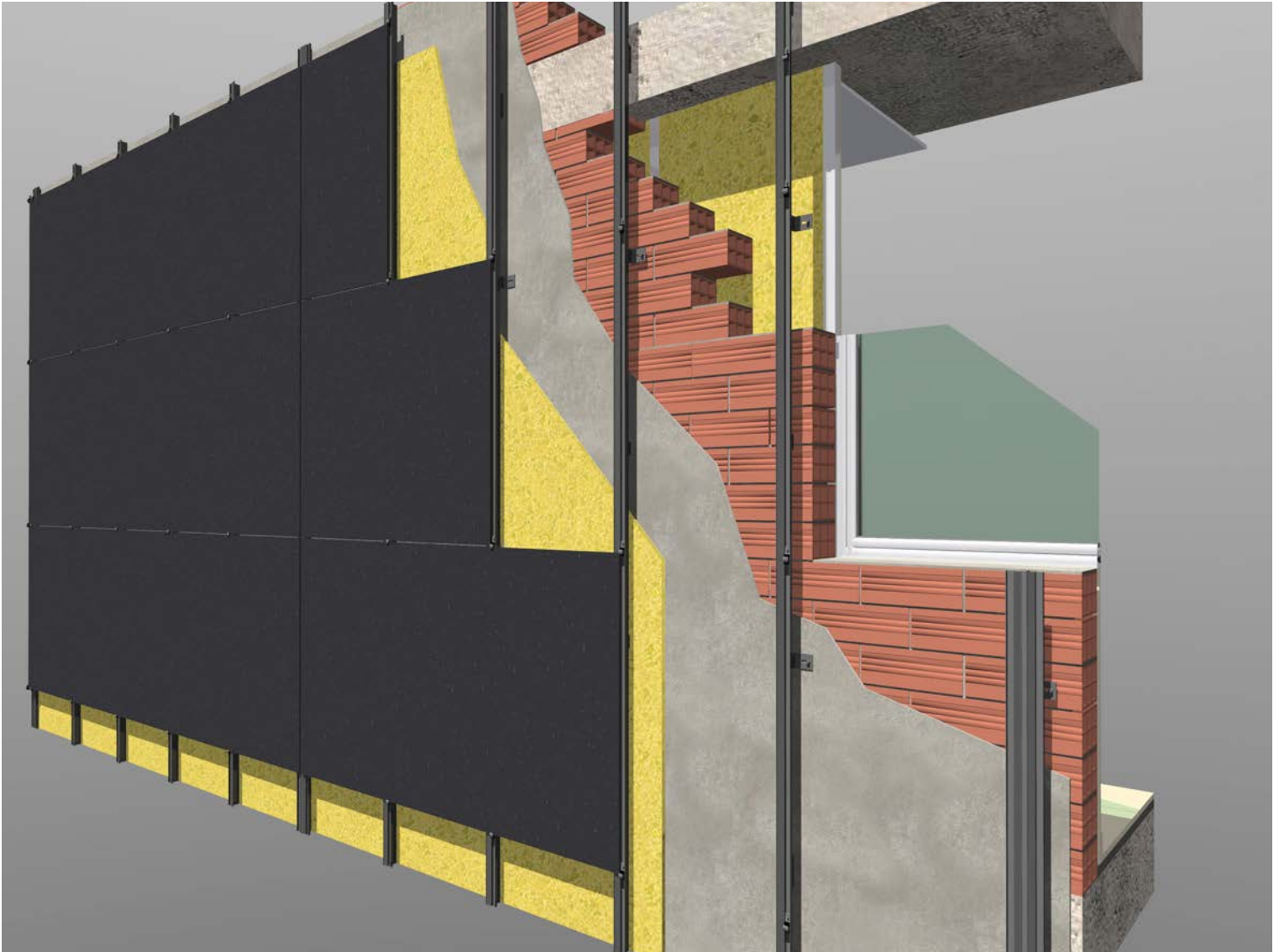

Image 25: VM System mockup

- 1.-Thermal Insulation
- 2.-ESC Aluminum 100x65x60x3
- 3.-Vertical aluminum profile "T 100x50x2"
- 4.-Aluminum Clip System
- 5.-Adhesive PanelTack-HM
- 6.-Neolith Slab

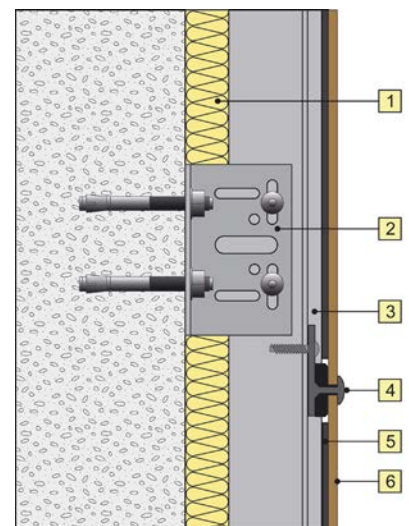

Image 26: VM System vertical section

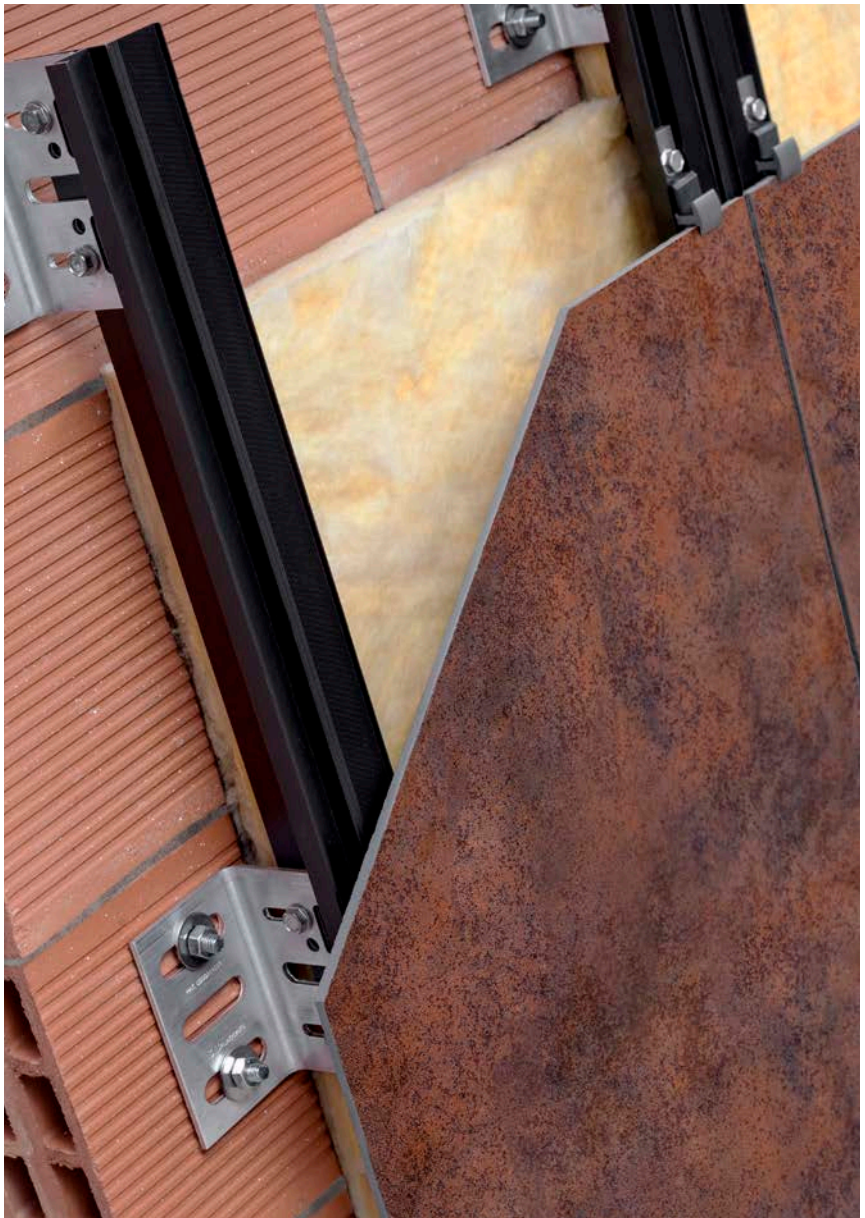

Image 27: VM System detail



Image 28: VM System details

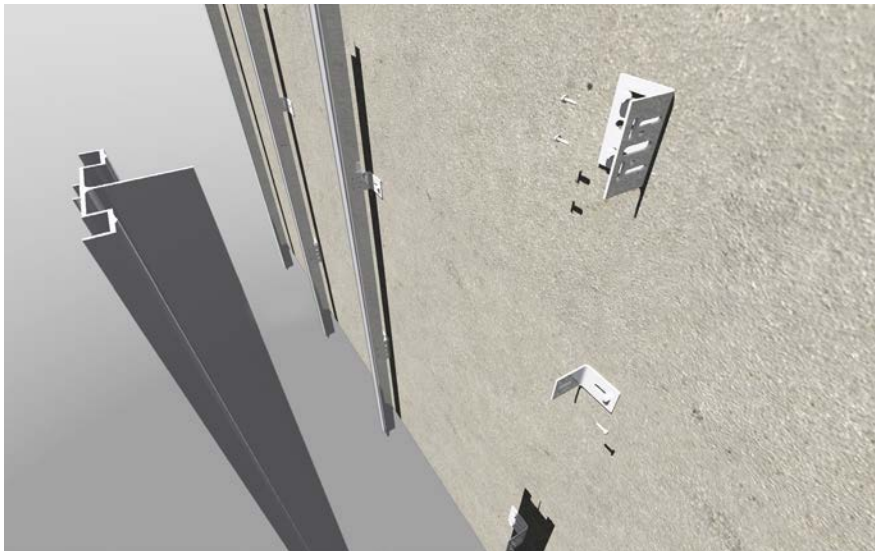

Image 29: VM System installation Step 1



Image 30: VM System installation Step 2

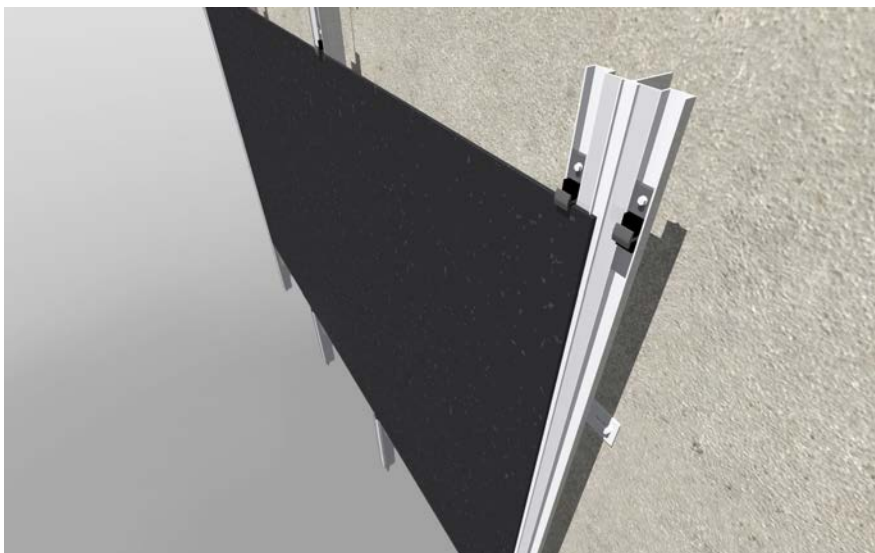

Image 31: VM System installation Step 3

Substructure distribution and installation:

Dimensions of the perpendicular substructure depend on the façade construction. The distances between the substructure battens and their width are determined by the load requirements and by the type of Neolith panel used.

Application Method:

Position and screw Aluminum Clip supporting system, distance between clips are determined by engineering loads calculus, take in care if clips are bottom-coronation or standard type.

Apply Structural Adhesive in a triangular bead by using the triangular nozzle supplied (width 8

mm, height 10 mm) on fluted channel of T profile.

Place the cladding Neolith panel on the position, insert the slab into the aluminum clip system and precisely and press them firmly until they contact the Structural Adhesive Panel fixing, subsequently close the fixation in the upper part with next line of aluminum clips.

Vertical joint will limited up to 3mm.

Component details

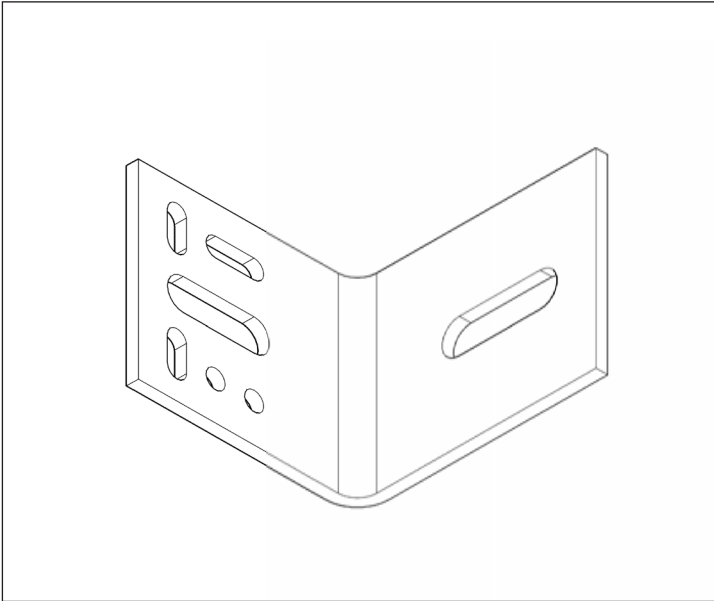

Image 32: Supporting bracket

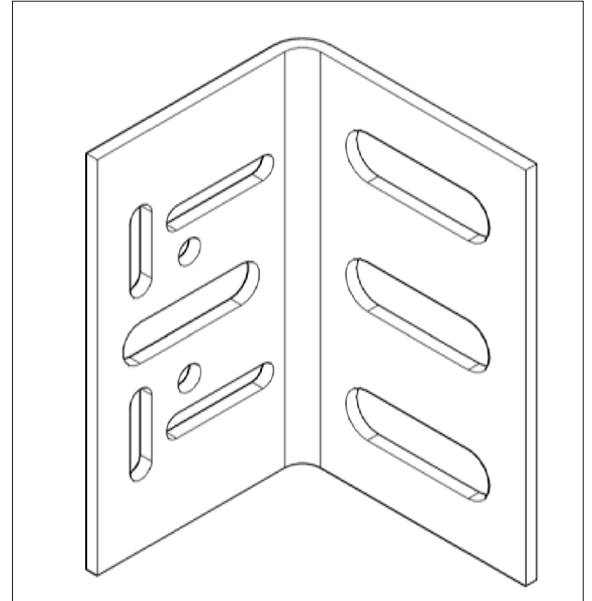

Image 33: Retention bracket

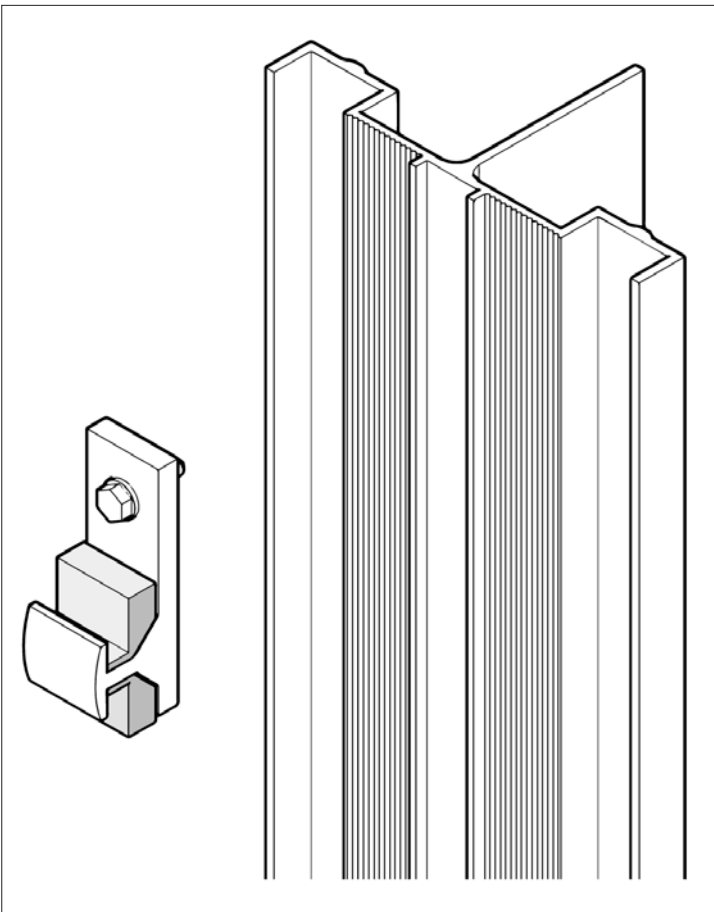

Image 34: Vm System vertical profile and mechanical Clip

Summary Components

Components	Materials
Vertical Profile	Al 6063 T5
Brackets	Al 6063 T5
Screws and Fixations	AISI 304/316

Table 8: Component details

Main characteristics of the material

Characteristics Al 6063 T5	
Specific Gravity	2.700 kg/m ³
Coefficient of Thermal Expansion from 20 to 100 °C	23,6 x 10 ⁻⁶ K ⁻¹
Modulus of elasticity	69.500 N/mm ²
Poisson Coefficient	0,33
Tensile Resistance	215 N/mm
Shear Resistance	140 N/mm ²
Yield stress (Rp 0,2%)	160 N/mm
Elongation (L0-mm)	12%
Elongation (L50-mm)	14%
Brinell Hardness	70

Table 9: Al 6063 T5

Characteristics AISI 304	
Specific Gravity	7.930 Kg/m ³
Coefficient of Thermal Expansion from 20 to 100 °C	17,3 x 10 ⁻⁶ K ⁻¹
Modulus of Elasticity	190.000 N/mm ²
Poisson Coefficient	0,33
Tensile Resistance	540-750 N/mm
Yield stress (Rp 0,2%)	≥ 230 N/mm
Elongation (L0-mm)	< 45%
Brinell Hardness	183

Table 10: AISI 304

Installation process

The system must be executed by qualified or specialized companies under the supervision of the Project Manager.

1. **Safety Conditions:** The components of the system should be correctly kept in the building site, foreseeing a place where they cannot be damaged by blows or the action of different atmospheric agents.
2. **Prior Verifications:** Once the structure of the building is executed or the supporting structure system, it must be verified, from the plans provided by the project management, that the modulation and the initial calculus of materials (cladding, brackets and moorings) considered in the projectual stage are the appropriate ones to start with the installation of the system.
3. **Levelling of the supporting structure:** This verification must be done with mechanical or digital means, quantifying the out of plumb of the supporting structure. These “out of plumb” with the width of the air chamber, will define the maximum and minimum dimension of separation between brackets.
4. **Setting-out in site:** Once the prior verifications are done, the separation distances between vertical profiles will be set depending on the dimension of the chosen panels in the project and the calculus limitation.
5. **Brackets Fixation:** The kind of screws and fixations which are used to join the brackets to the building together will depend on the supporting structure where they will be fixed. In other words, depending on the material of the structure or the enclosure of the building, a different kind of mooring will be recommend.
6. **Supporting Brackets:**
 - SLAB. In most of the cases, supporting brackets are fixed to reinforced concrete slab with MTA 10x90 metallic stainless A-2 mooring. These moorings are located in the upper and lower oval-hole of the brackets to ensure at least the minimum separation between metallic moorings.
 - ENCLOSURE. In exceptional cases, it is necessary to fix the supporting bracket in areas where there is no slab (window contour, high parameters, corbels...). In these cases, it will be used a stainless A-2 plug nylon set FL 10x90, consisting of a stainless A-2 DIN 571 8x100 screw, a FL 10x90 nylon plug and a stainlessA-2 M-8 9021 washer. Depending on the typology and the resistance of the enclosure, it could be more suitable and/or necessary another kind of nylon plug or chemical mooring with threaded rod (consisting of a 8x120 stainless A-2 threaded rod, 12x80 sieve and epoxy resin without etilen).



Image 35: MTA 10x90 metallic stainless A-2, A-2 DIN 571 8x100 screw and a FL 10x90 nylon

7. **Retention Bracket:** Once the moorings for each bracket, after the calculus and verifications, have been chosen; the brackets will be fixed following the initial setting-out, taking into account the following indications:

Vertical distances between brackets will be specified in each case depending on the calculus of the chosen profile. In no case the maximum distance must be exceeded.

Retention brackets must have a staggered pattern along the profile for a proper functioning.

8. **Fixed point:** These will be screws type DIN 7504 K 6.3x25 made of stainless steel A-2. They receive gravity and wind loads and transmit them to supporting angle brackets.

In this case, screws are placed in the circular drillings, with a specific diameter which avoids any movement.

Every fixed point should have the prescribed tightening torque from the manufacturer's technical specifications.

9. **Floating point:** It will be used screws type DIN 7504 K 4.8x19 made of stainless steel A-2. They will fix vertical profiles to angle brackets allowing movements caused by thermal expansions.

To ensure an optimal efficiency, screws will be fixed in the central point of the brackets vertical oval-holes. Even though certain position variations are allowed, direct contact with the upper or lower part of the oval-hole must be avoided. In that case, movements would be completely restricted and the behavior would not be the appropriate.

10. **Supporting angle brackets:** Fixed point. Two screws receive the gravity load from a profile (either the upper or the lower profile) and they transmit it to the angle brackets. The right positions are prescribed in the following figures.

11. **Floating points:** A screw will be placed in the center of the recommended oval-hole. Not only the right position of the profile is guaranteed but also some possible differential movements are allowed, forcing the profile to work with a flexo-traction or flexo-compression behavior.

12. **Retention Angle Bracket:** Floating points. Two screws will be placed in the vertical oval-holes. They will be also placed in both centers in order to allow some differential movements produced by thermal expansions of the material.

13. **Fixation of staples, adhesive lines and cladding panels:** Once profiles are all installed, staples will be placed, beginning from the starting ones, in the bottom part of the cladding. Then, they will be fixed to the profiles with the stainless steel self-drilling screws specified.

The adhesive should be now put along the profile, in the grooved areas. It will be in two lines in the intermediate "T" shaped profiles, and just one line in "L" shaped profiles. Each panel should be adjusted to its right position and finally fixed with with the intermediate and ending staples, depending on the characteristics of the facade.

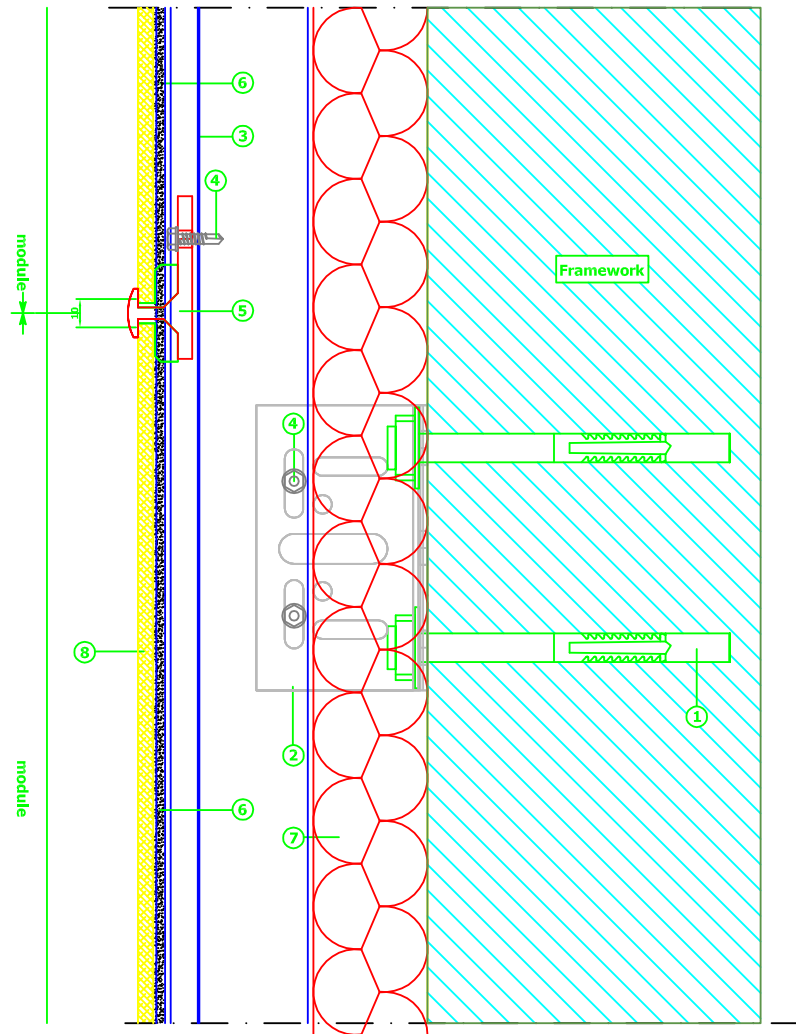

- 1 Bracket MTA 10x90 inox A2
- 2 ESC aluminum 100X65X60X3
- 3 Vertical aluminum profile "T 100X50X2"
- 4 Screw DIN 7504-K 6.3x25 inox A 2
- 5 Aluminum clip system
- 6 Adhesive PanelTack-HM
- 7 Aislante
- 8 Neolith

Image 36: VM System vertical system

2.3. STRONGFIX SYSTEM

Mixed hidden longitudinal fastening system

The Strongfix system is a mixed hidden longitudinal fastening system (chemical and mechanical), which works by the compression exerted by the system on the back of the Neolith tile.

These tiles are industrially mechanized in a longitudinal profile at the top and bottom of its backside with a double 45° groove in the shape of a dovetail where a couple of aluminum profiles are inserted and fixed with a MS adhesive putty in order to secure the Neolith tile. These metal profiles make up the hanging mechanism of the tiles and result very beneficial given that they are very easy to extract and replace.

The system is composed by aluminum vertical profiles, supporting retaining brackets. Through the brackets it's possible to install the aluminum "T" profiles totally flatness, thus correcting possible wall deviations of the facade to be coated.

The panels are hand set to a horizontal supporting profile with a mechanical longitudinal fixation system composed by two aluminum profiles fixation.

This aluminum set becomes indivisible given the mechanizing method of the tile and the fixing of the profiles. This system eliminates the risk of Neolith slabs becoming detached from the structure in case of breakage. This is the reason why this system is considered the safest in the market.

Furthermore, the way in which the Neolith slabs are hung on the horizontal structure provides for perfect flatness and aesthetic finish.

The Strongfix system also allows for easy extraction and replacement when needed.

- 1.- Thermal Insulation
- 2.- Vertical Aluminum "T 100x50x2"
- 3.- Aluminum fixing profile
- 4.- Aluminum fixing profile
- 5.- Horizontal Strongfix profile
- 6.- ESC Aluminum 100x65x60x3
- 7.- Neolith Slab

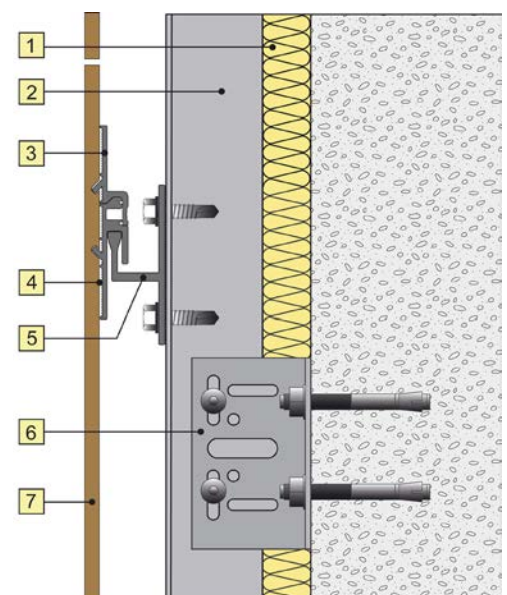

Image 38: Strongfix System vertical section



Image 37: Strongfix System mockup



Image 39: Strongfix System detail

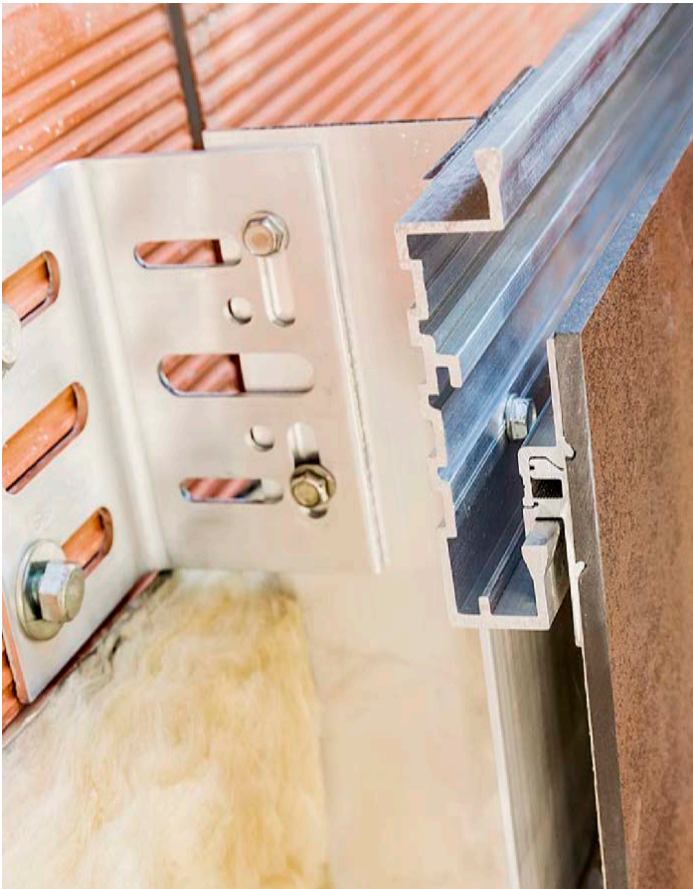
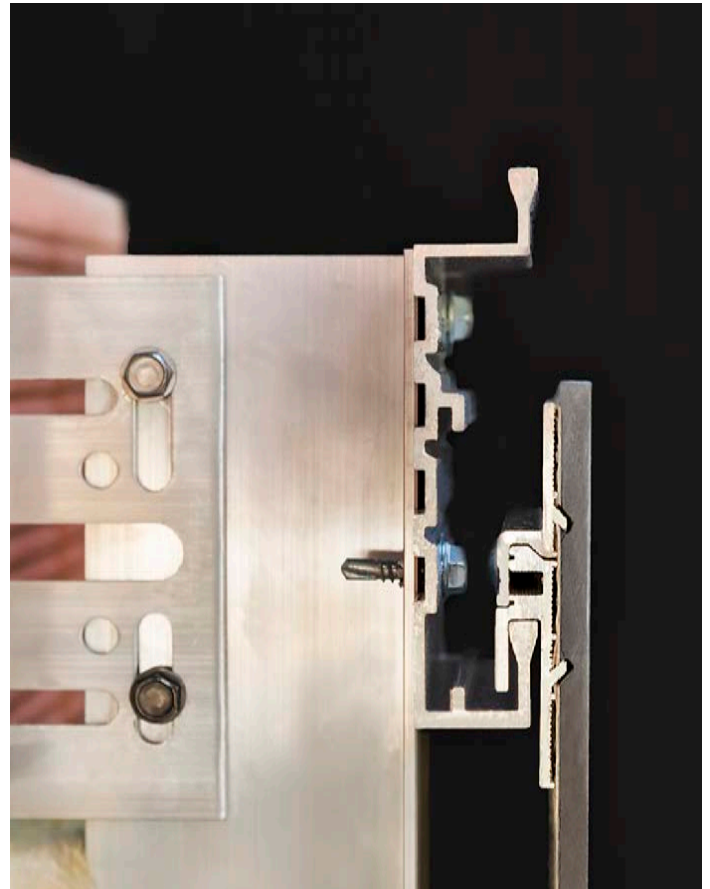

Image 40: Strongfix System details



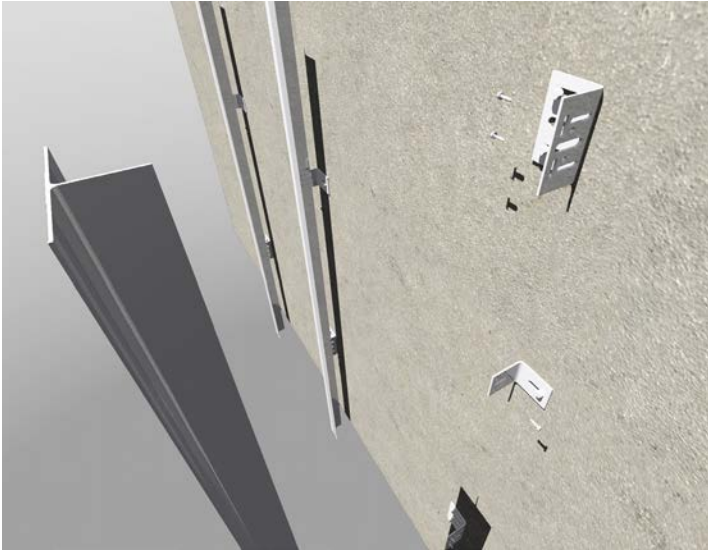

Image 41: Strongfix System installation Step 1

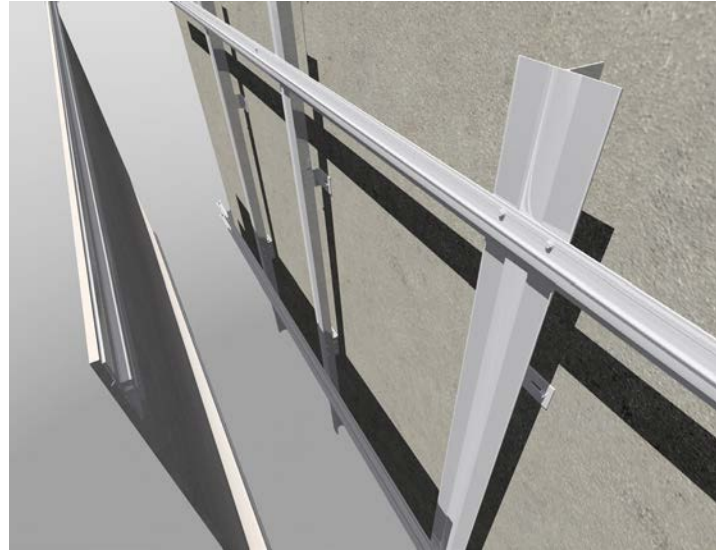

Image 42: Strongfix System installation Step 2



Image 43: Strongfix System installation Step 3

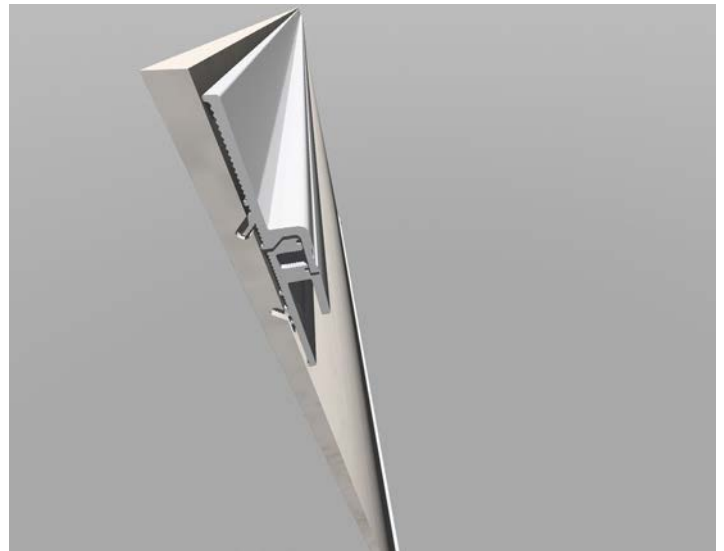

Image 44: Neolith slab with the Strongfix System profiles

Component details

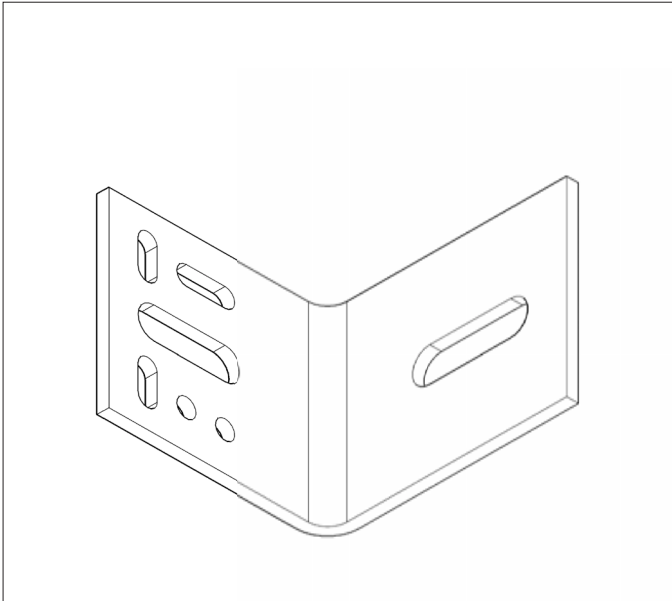

Image 45: Supporting bracket

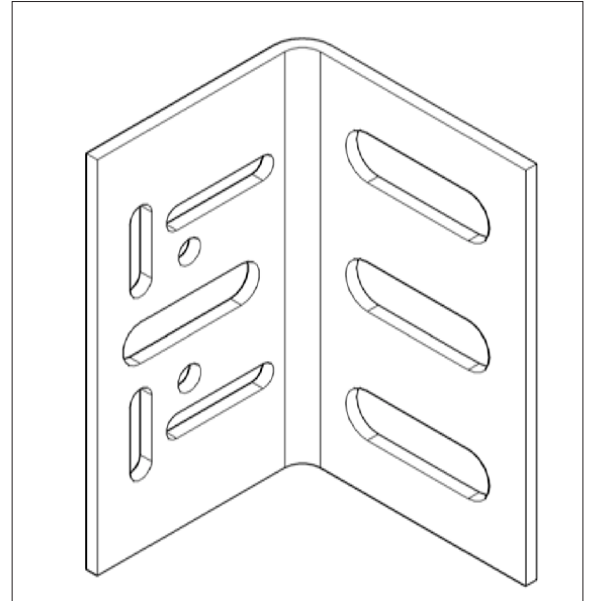

Image 46: Retention bracket

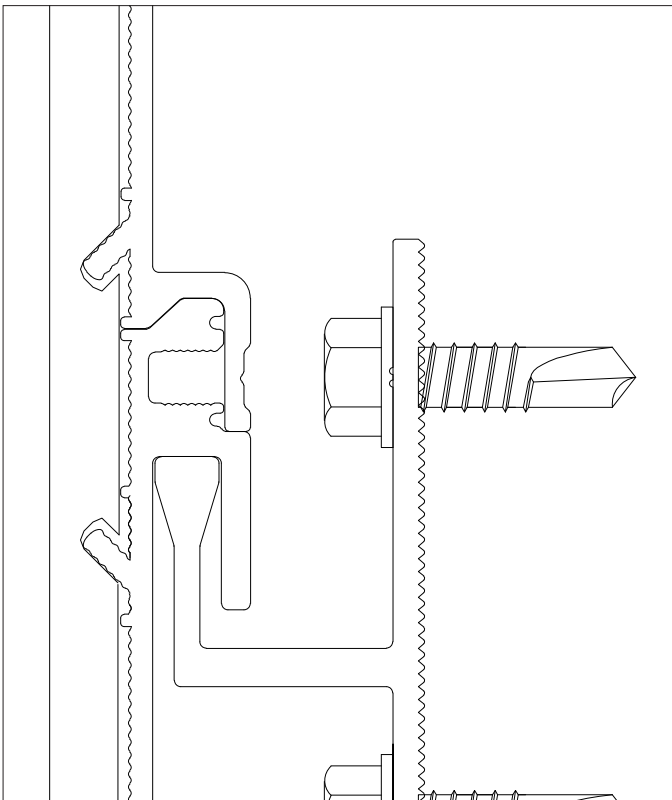

Image 47: Strongfix System detail

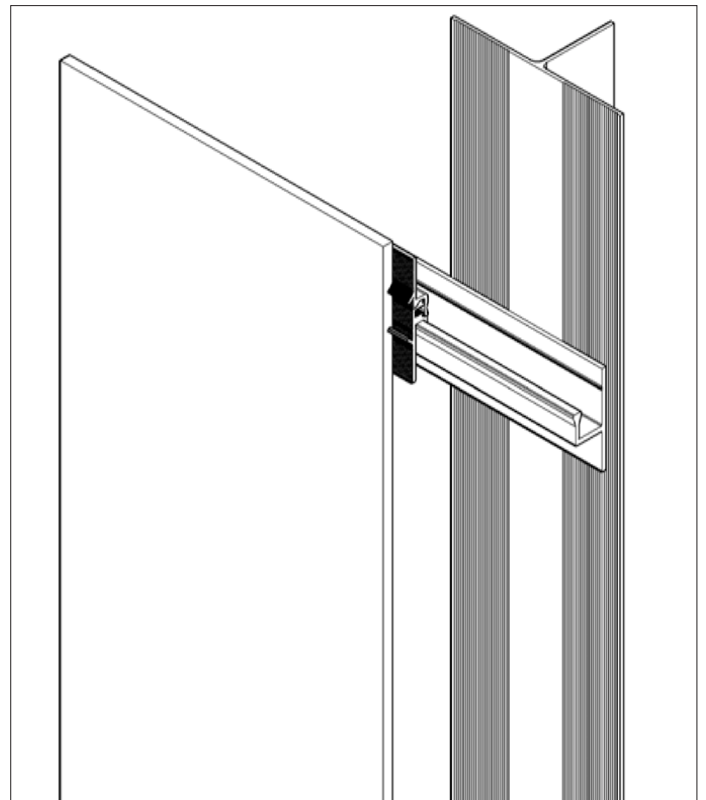

Image 48: Strongfix System detail

Summary Components

Components	Materials
Vertical Profile	Al 6063 T5
Brackets	Al 6063 T5
Screws and Fixations	AISI 304/316

Table 11: Component details

Main characteristics of the material

Characteristics Al 6063 T5	
Specific Gravity	2.700 kg/m ³
Coefficient of Thermal Expansion from 20 to 100 °C	23,6 x 10 ⁻⁶ K ⁻¹
Modulus of elasticity	69.500 N/mm ²
Poisson Coefficient	0,33
Tensile Resistance	215 N/mm
Shear Resistance	140 N/mm ²
Yield stress (Rp 0,2%)	160 N/mm
Elongation (L0-mm)	12%
Elongation (L50-mm)	14%
Brinell Hardness	70

Table 12: Al 6063 T5

Characteristics AISI 304	
Specific Gravity	7.930 Kg/m ³
Coefficient of Thermal Expansion from 20 to 100 °C	17,3 x 10 ⁻⁶ K ⁻¹
Modulus of Elasticity	190.000 N/mm ²
Poisson Coefficient	0,33
Tensile Resistance	540-750 N/mm
Yield stress (Rp 0,2%)	≥ 230 N/mm
Elongation (L0-mm)	< 45%
Brinell Hardness	183

Table 13: AISI 304

Installation progress



Image 49: Strongfix System installation Step 1

1. **Façade staking:** Aluminum vertical profiles arrangement and staking, which can be installed completely independent to the vertical joints.

2. **Vertical profiles installation:** The vertical structure is anchored to the wall using retencion and supporting brackets and anchors.

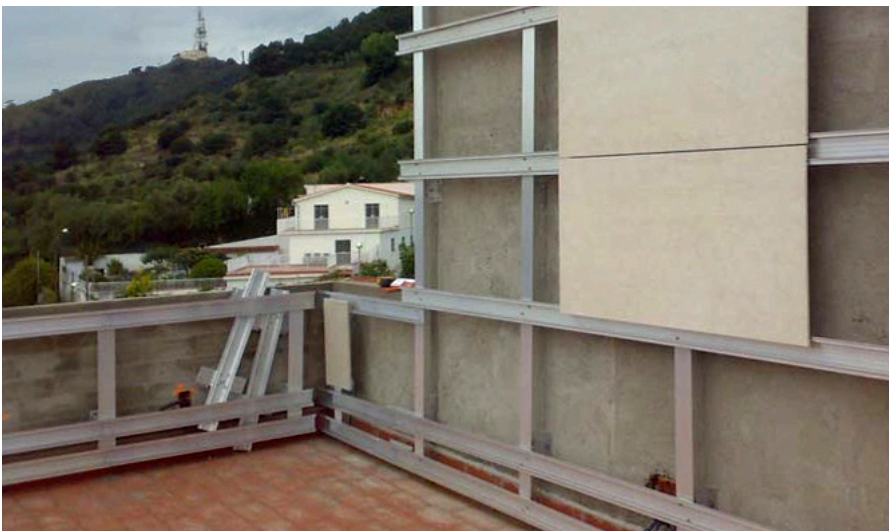

Image 50: Strongfix System installation Step 2 and 3

3. **Horizontal profiles installation:** It is needed to be determined the horizontal profiles position, in response to horizontal cutting façade scheme. This structure is anchored to the vertical structure by 5.5x19cm drilling screws.

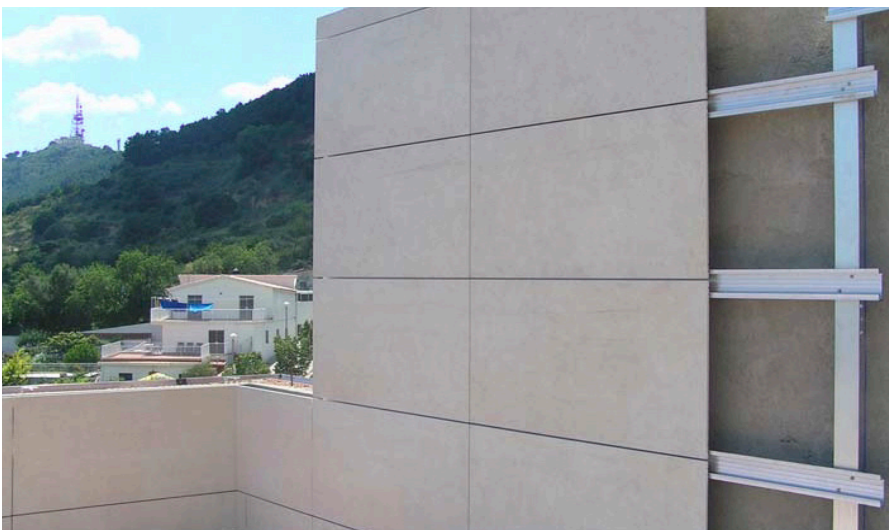
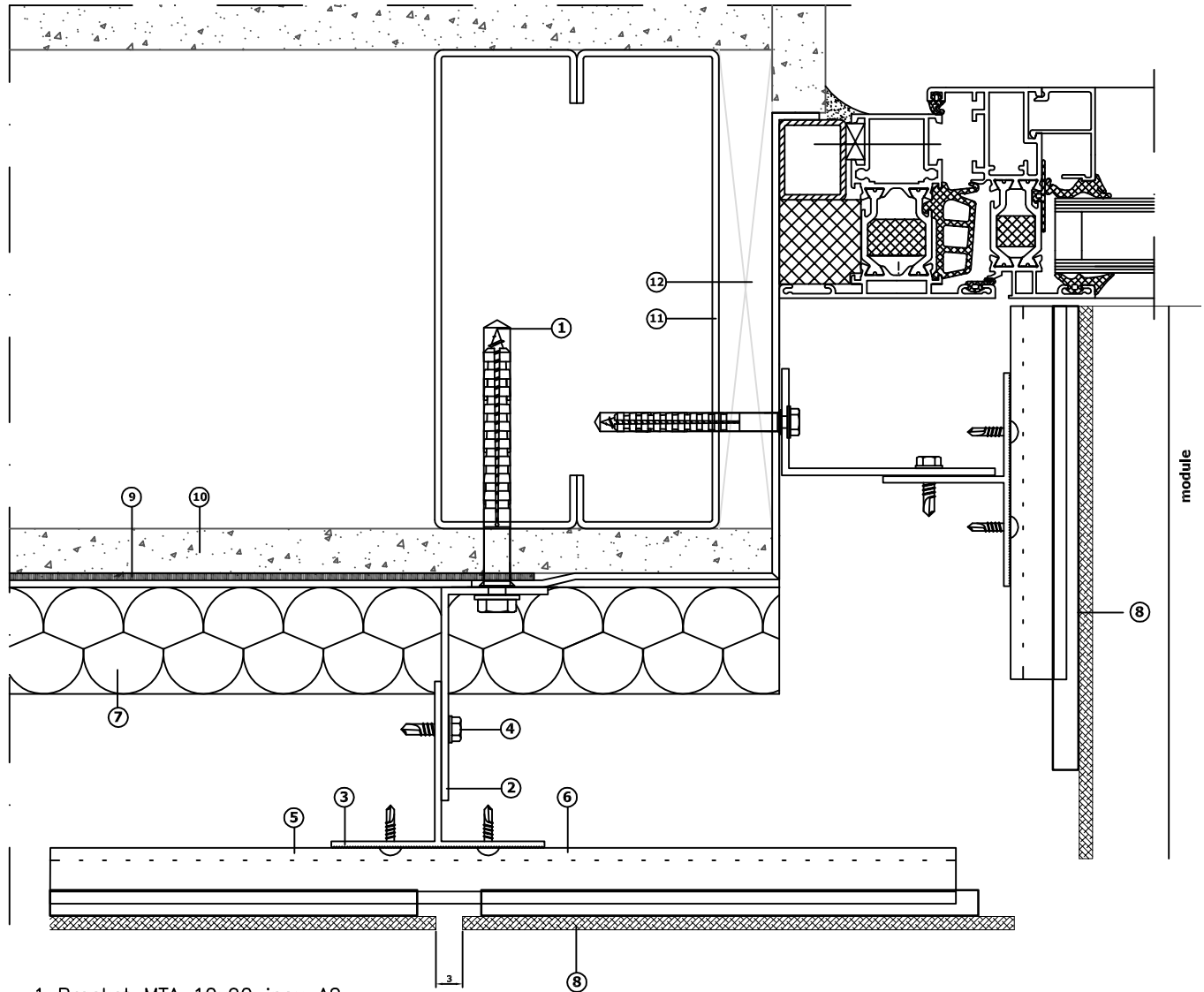

Image 51: Strongfix System installation Step 4

4. **Neolith installation:** Neolith cladding installation, it is needed to start by the bottom of the façade. It is a façade system very fast to install which allows to replace the slim tiles if it is required.

Jamb details. Strongfix system. Horizontal section



- 1 Bracket MTA 10x90 inox A2
- 2 ESC aluminio 8040x120x3
- 3 Vertical aluminum profile "T 110x50x2"
- 4 Screw DIN 7504-K 6.3x25 inox A 2
- 5 Fixing Profile
- 6 Horizontal Aluminum Profile
- 7 Insulation
- 8 Neolith
- 9 Moisture barrier
- 10 Gypsum wallboard
- 11 Metal studs
- 12 Blocking

Jamb details. VM system. Horizontal section

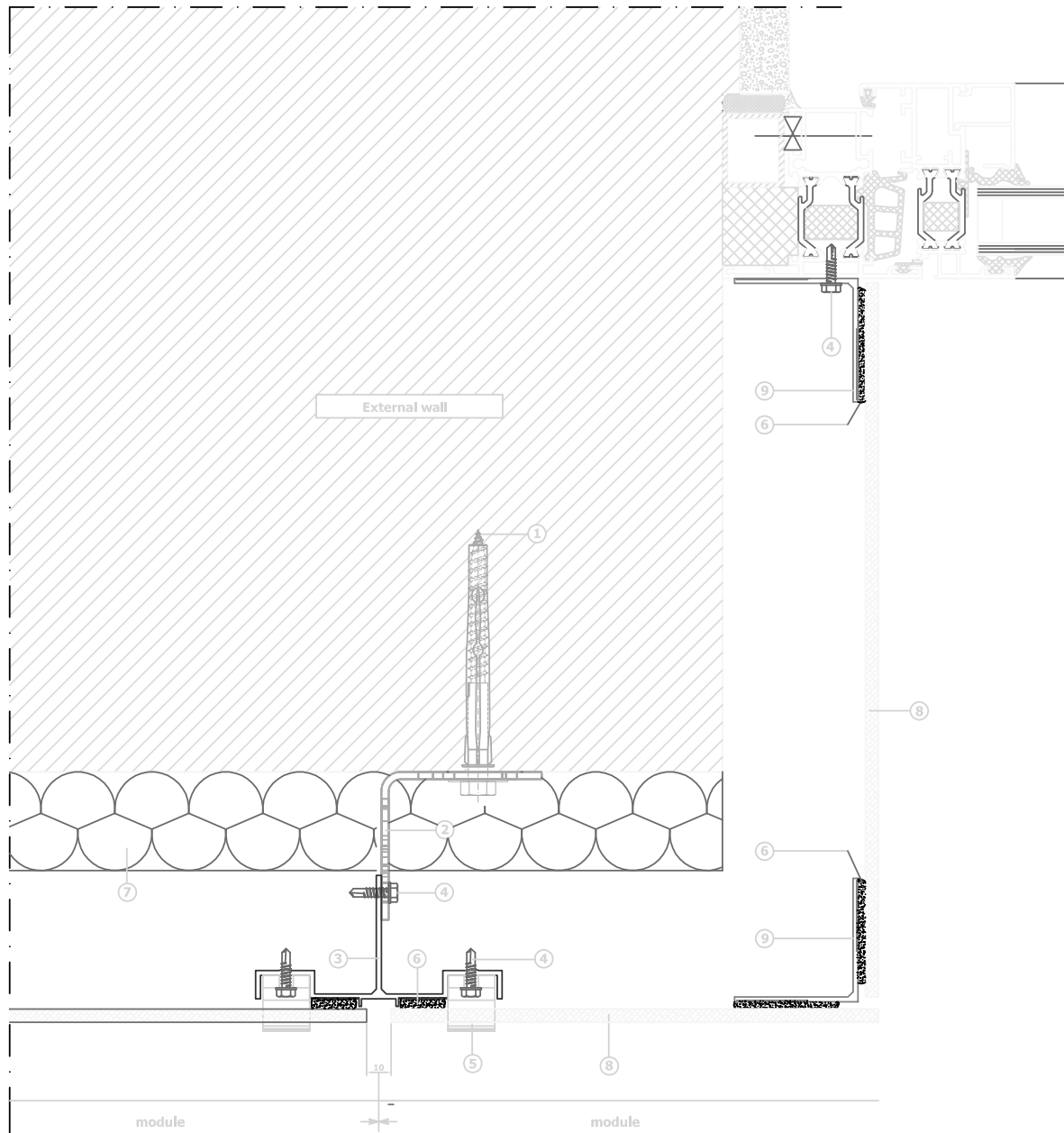

- 1 Set nylon FL 10x90
- 2 ESC aluminum 100X65X60X3
- 3 Vertical aluminum profile "T 100X50X2"
- 4 Screw DIN 7504-K 6.3x25 inox A 2
- 5 Doble side tape
- 6 Ahesive PanelTack-HM
- 7 Insulation
- 8 Neolith
- 9 L profile 50x50x2 stried

Dintel detail. Strongfix system. Vertical section

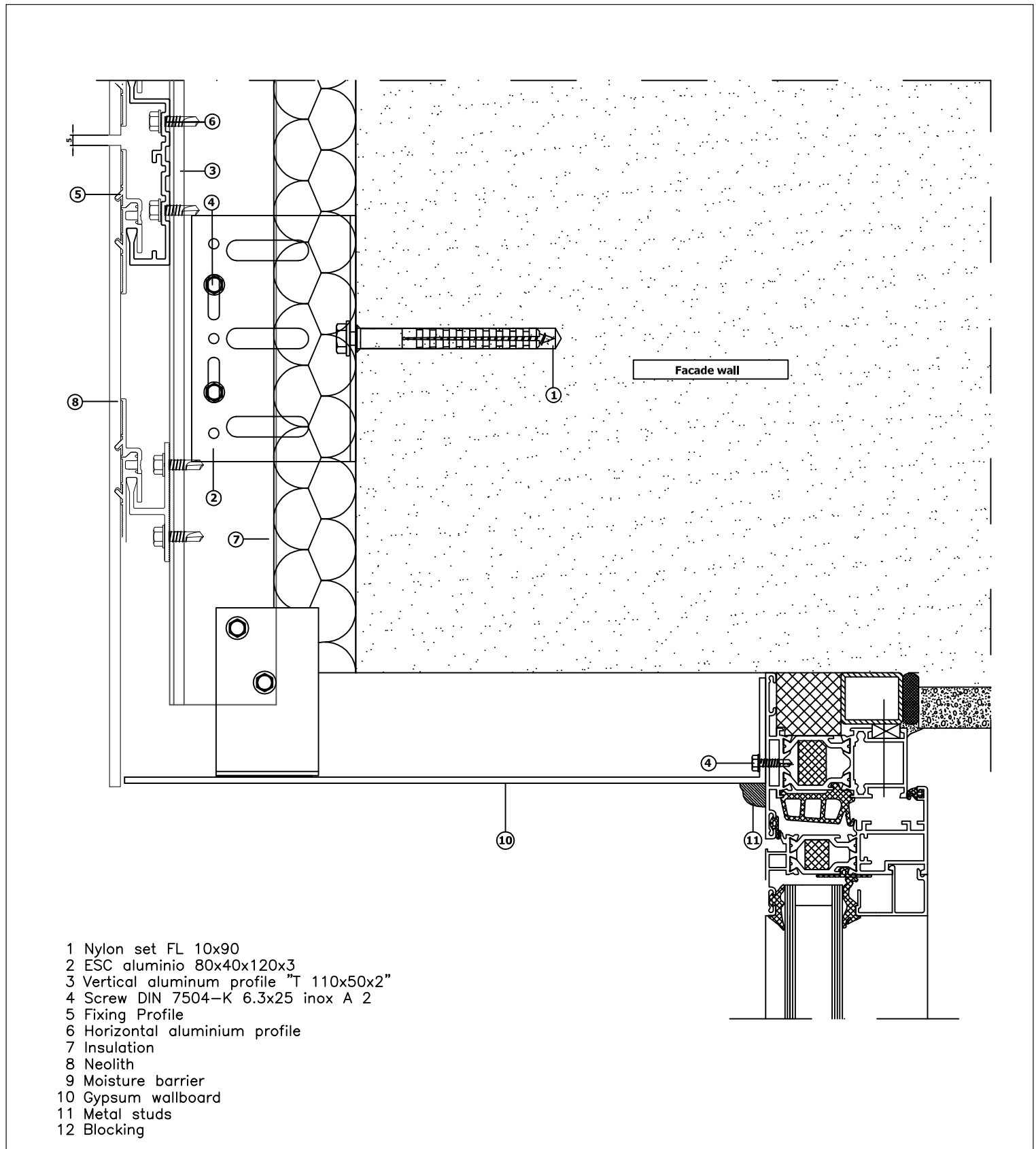

Dintel detail. VM system. Vertical section

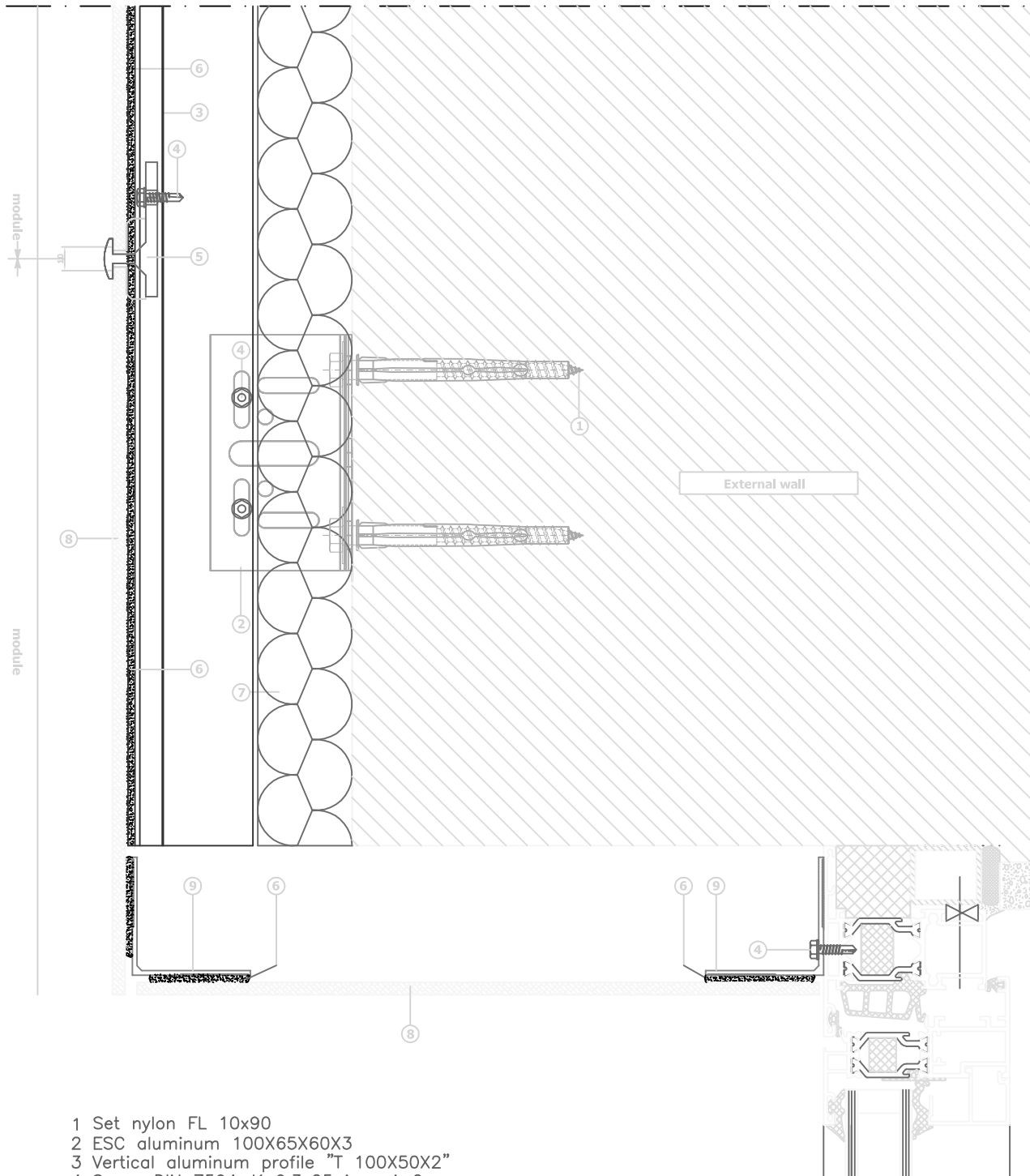

- 1 Set nylon FL 10x90
- 2 ESC aluminum 100X65X60X3
- 3 Vertical aluminum profile "T 100X50X2"
- 4 Screw DIN 7504-K 6.3x25 inox A 2
- 5 Doble side tape
- 6 Ahesive PanelTack-HM
- 7 Insulation
- 8 Neolith

Sill detail. Strongfix system. Vertical section

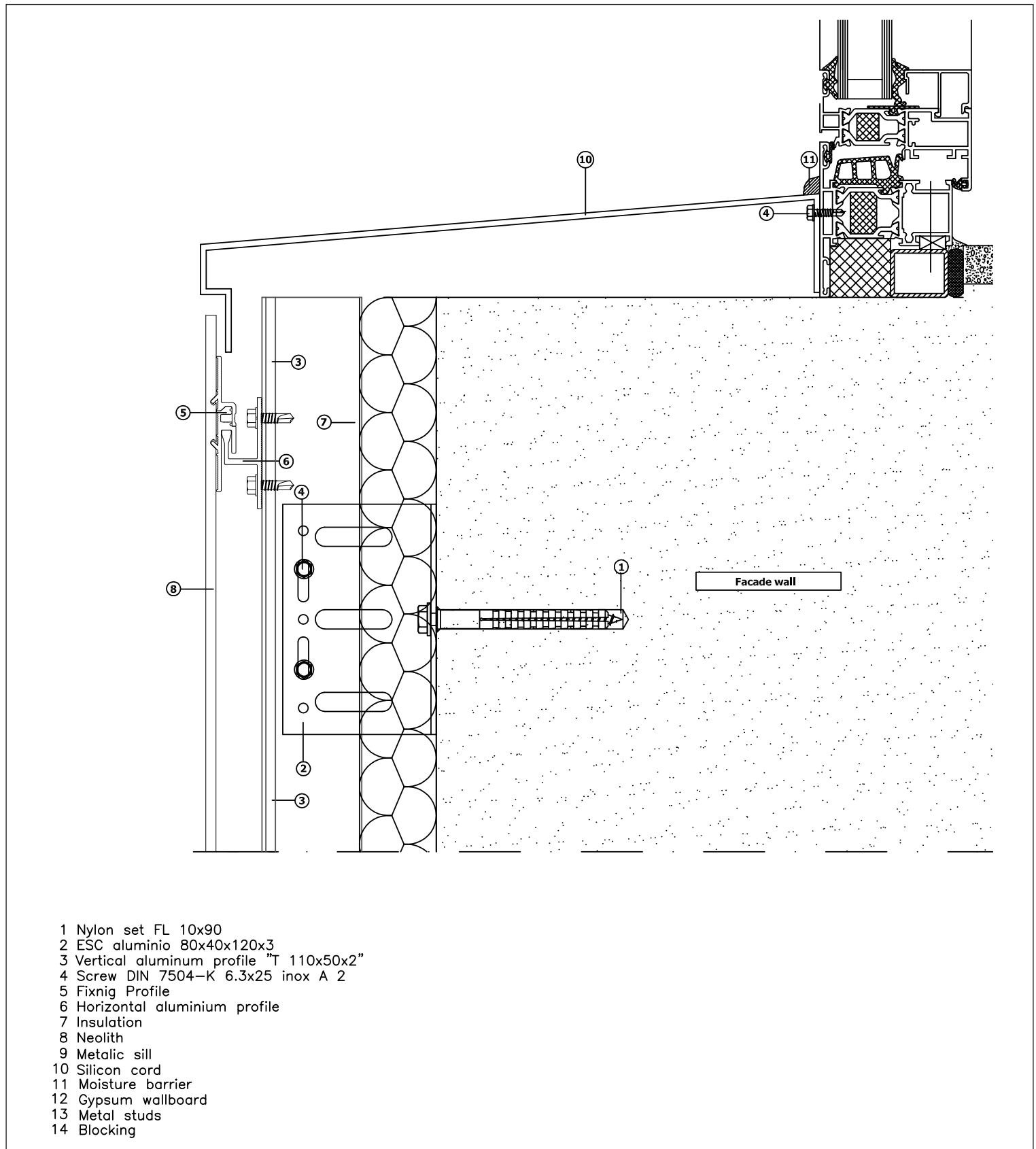

Sill detail. VM system. Vertical section

- 1 Set nylon FL 10x90
- 2 ESC aluminum 100X65X60X3
- 3 Vertical aluminum profile "T 100X50X2"
- 4 Screw DIN 7504-K 6.3x25 inox A 2
- 5 Doble side tape
- 6 Ahesive PanelTack-HM
- 7 Insulation
- 8 Neolith
- 9 Profile L 50x50x2 fluted
- 10Metalic sill
- 11Silicon cord

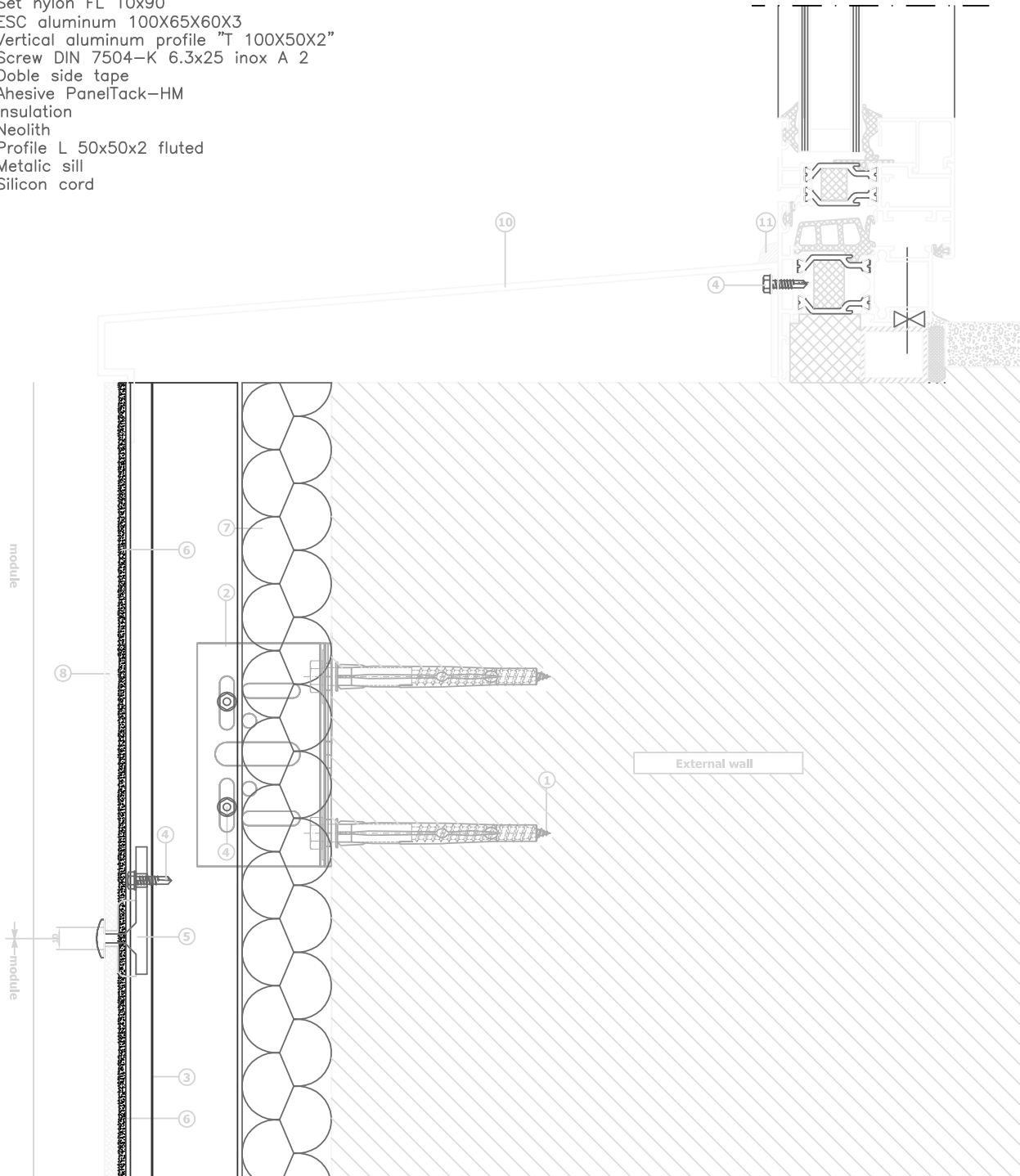

Coronation details. VM system. Vertical section

- 1 Set nylon FL 10x90
- 2 ESC aluminum 100X65X60X3
- 3 Vertical aluminum profile "T 100X50X2"
- 4 Screw DIN 7504-K 6.3x25 inox A 2
- 5 Doble side tape
- 6 Ahesive PanelTack-HM
- 7 Insulation
- 8 Neolith
- 9 Profile L 50x50x2 fluted
- 10Metalic sill
- 11Silicon cord

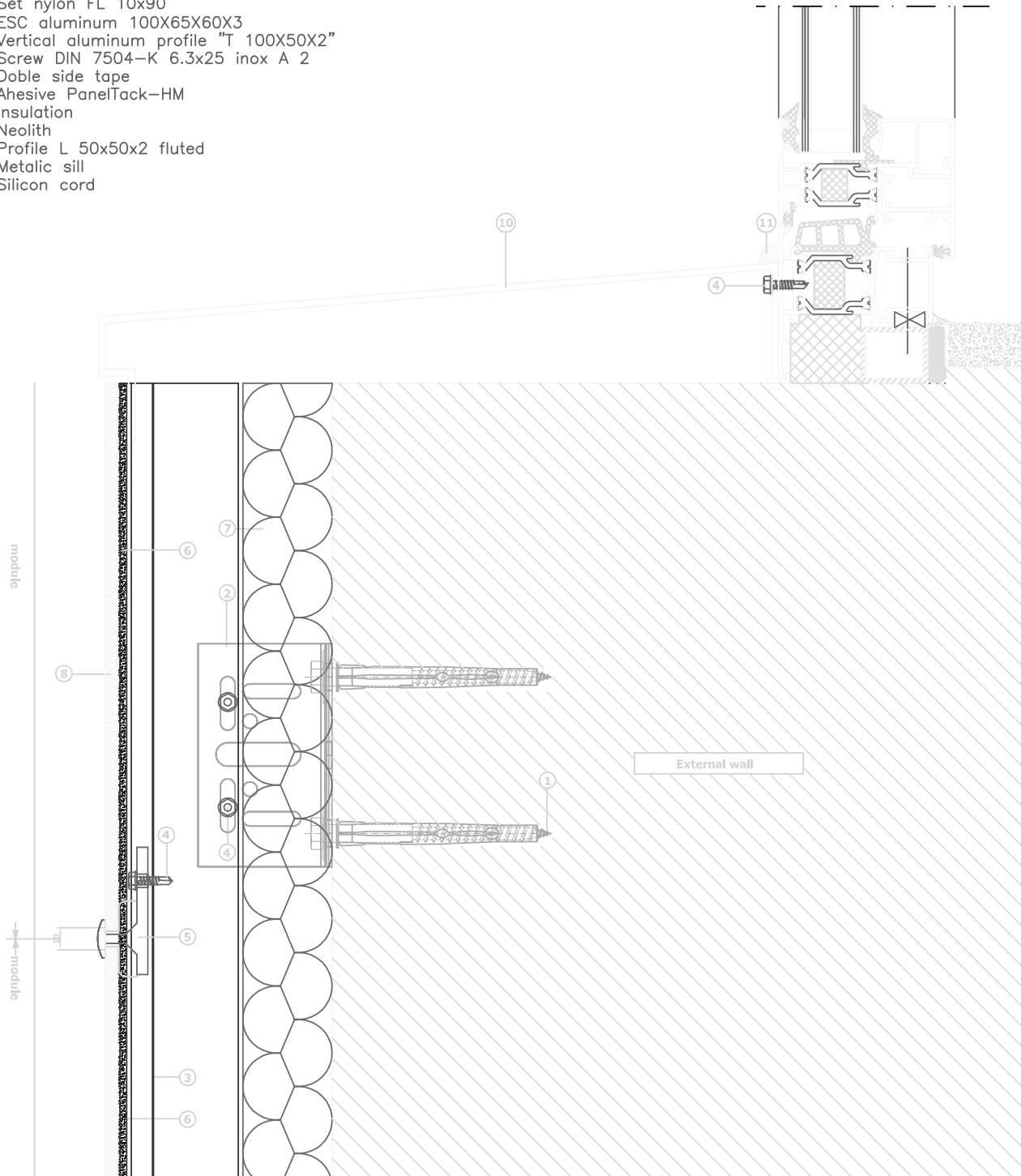

Coronation detail. Strongfix system. Vertical section

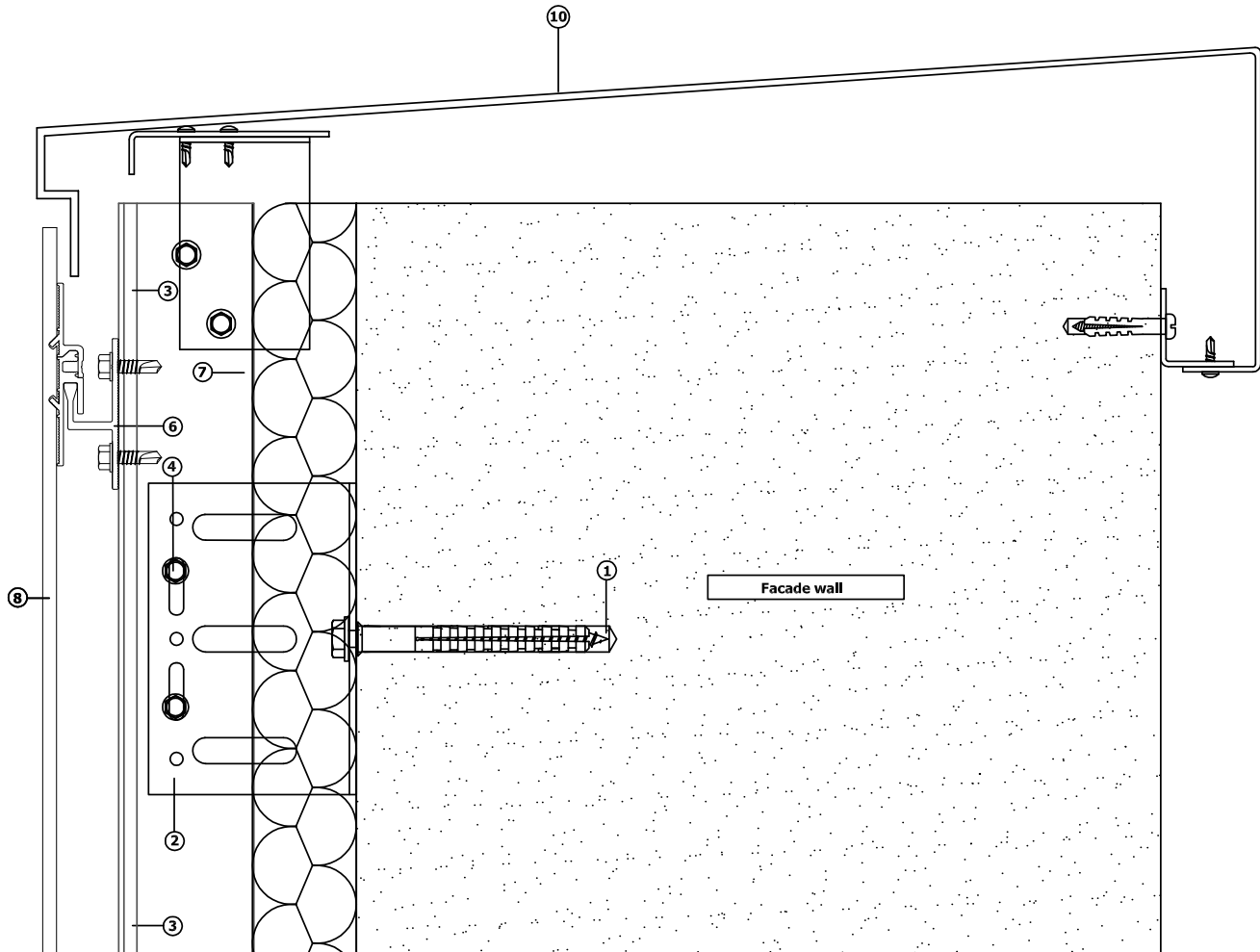

- 1 Nylon set FL 10x90
- 2 ESC aluminio 80x40x120x3
- 3 Vertical aluminum profile "T 110x50x2"
- 4 Screw DIN 7504-K 6.3x25 inox A 2
- 5 Fixing Profile
- 6 Horizontal Aluminum bar
- 7 Insulation
- 8 Neolith
- 9 Profile L 50x50x2 fluted
- 10Metalic coronation

Corner detail. Strongfix system. Horizontal section

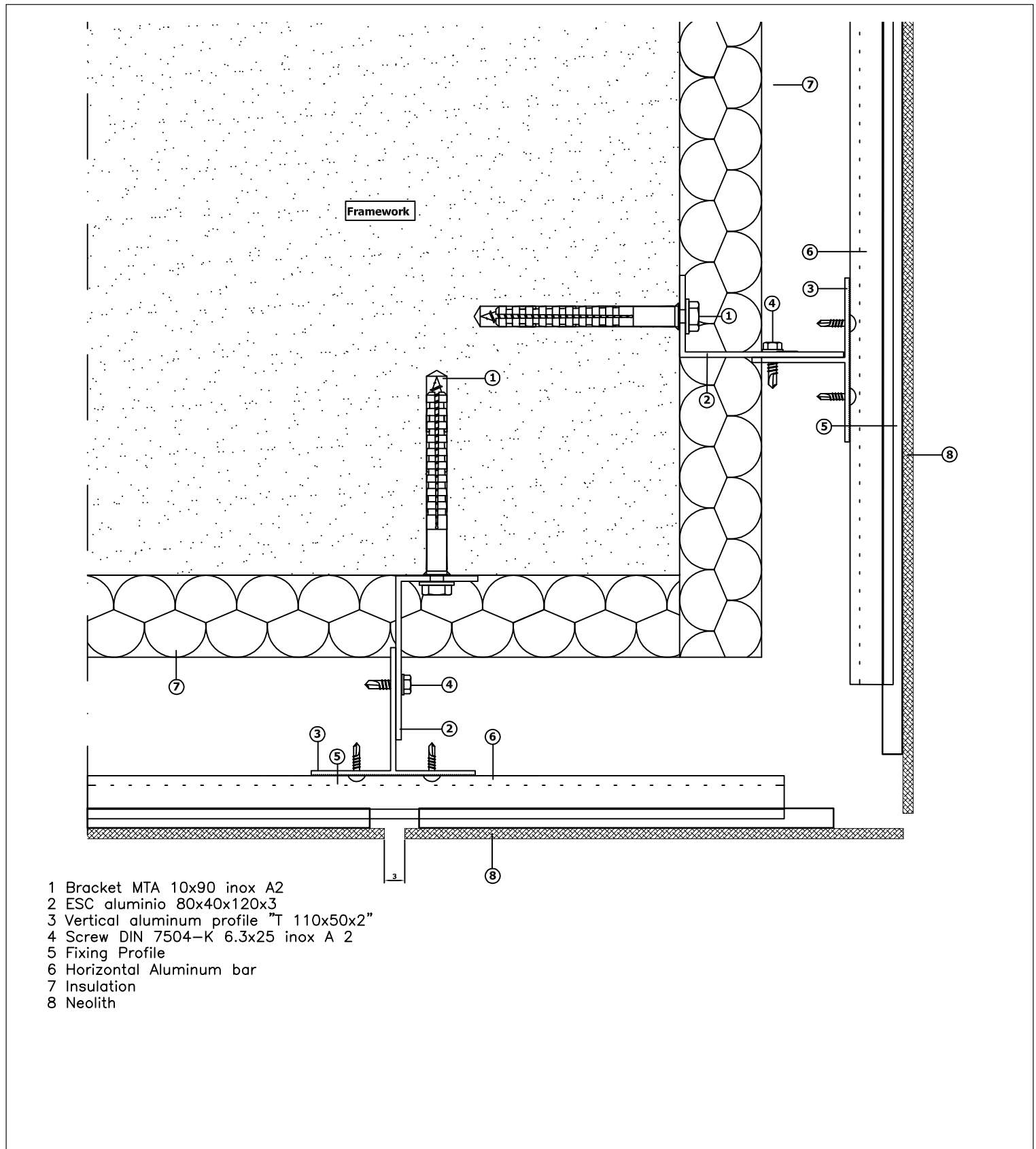

Corner detail. VM system. Horizontal section

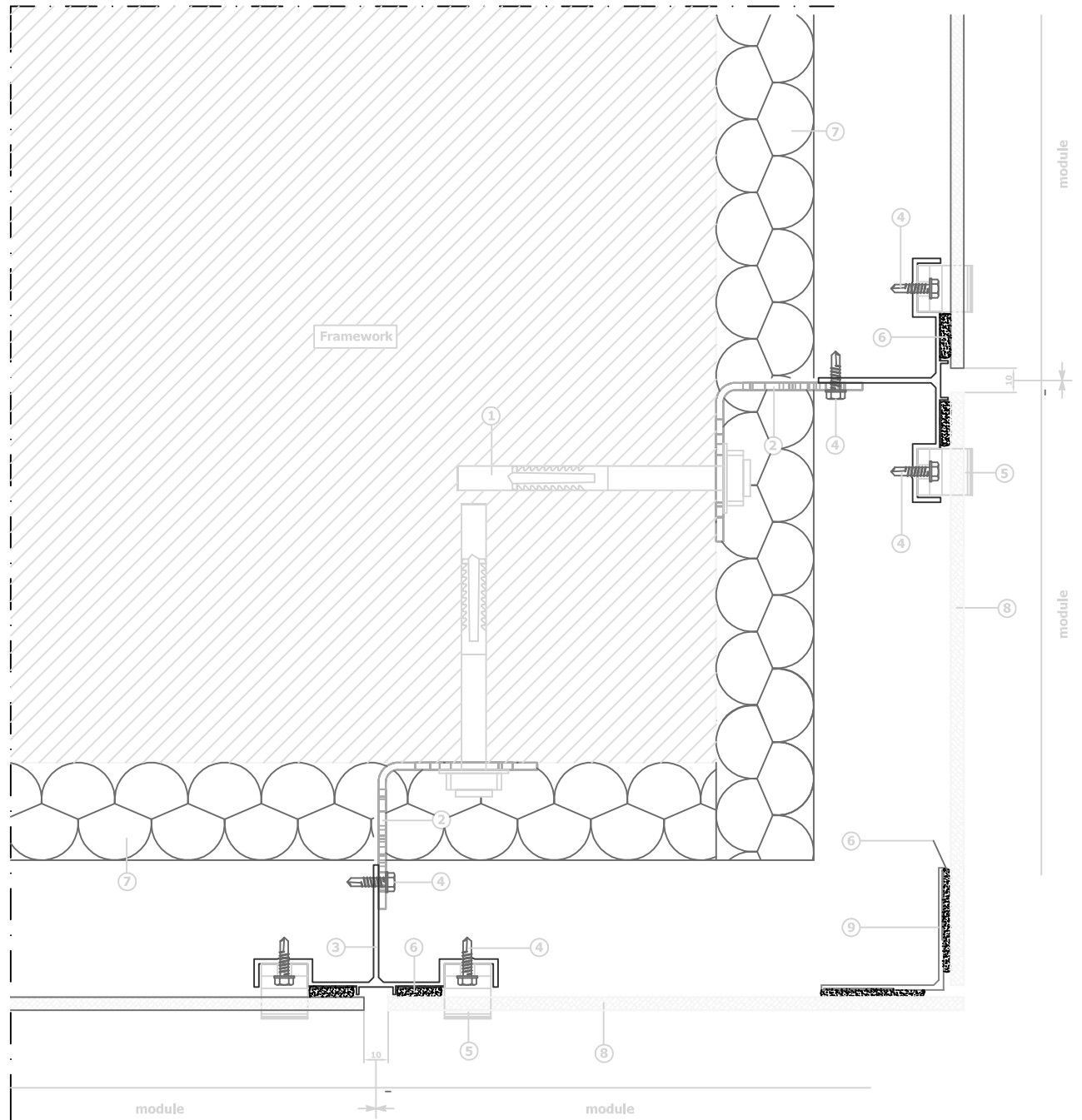

- 1 Bracket MTA 10x90 inox A2
- 2 ESC aluminum 100X65X60X3
- 3 Vertical aluminum profile "T 100X50X2"
- 4 Screw DIN 7504-K 6.3x25 inox A 2
- 5 Doble side tape
- 6 Ahesive PanelTack-HM
- 7 Insulation
- 8 Neolith
- 9 L profile 50x50x2 stried





VAUGHAN CIVIC CENTRE RESOURCE
LIBRARY
VAUGHAN (CANADA)

Ventilated Façade:
Belgian Blue, 6 mm+
Cladding System:
Ceramitex

Architects:
ZAS ARCHITECTS + INTERIORS

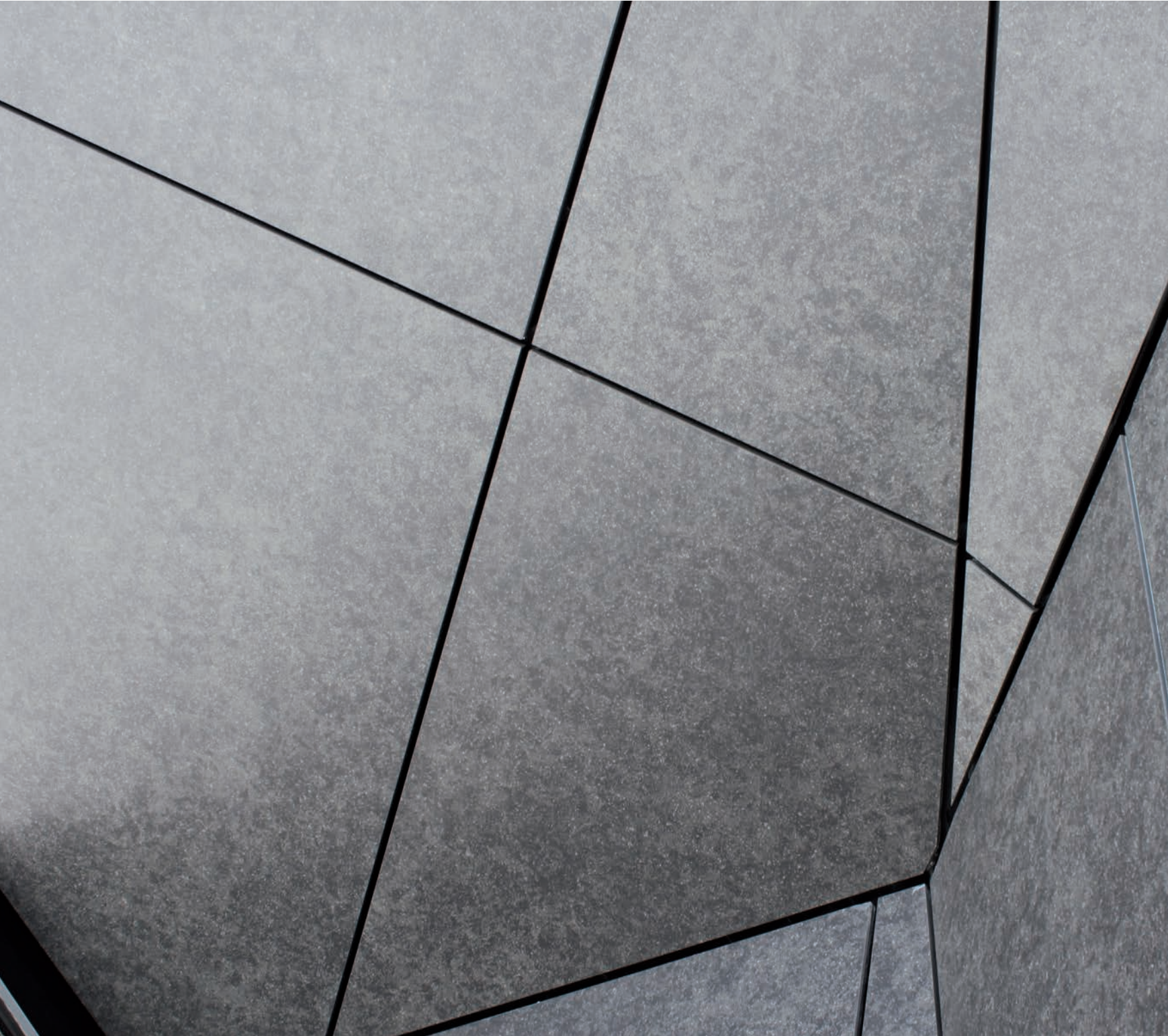

On the northern outskirts of Toronto, Vaughan Civic Centre is a new administrative campus of municipal buildings within one of Canada's fast growing cities. This new library represents a stand-alone building with strong urban design ties to the Civic Centre, yet at the same time asserting its own distinct architecture and identity. Neolith Belgian Blue has been integrated in the darkest parts of the façade being able to create whimsical shapes with strikingly sharp angles.

VAUGHAN CIVIC CENTRE RESOURCE
LIBRARY
VAUGHAN (CANADA)

Ventilated Façade:
Belgian Blue, 6 mm+
Cladding System:
Ceramitex

Architects:
ZAS ARCHITECTS + INTERIORS







SAN LEANDRO TECH CAMPUS
SAN LEANDRO (USA)

Ventilated Façade:
Iron Corten & Chocolate, 6 mm+

Cladding System:
HC SYSTEM

Designed by:
RMV ARCHITECTURE & INTERIORS



The SLTC buildings incorporates high quality, modern architectural design and meets the LEED Gold standards.

"One of the external technology features unique to the skin is the Neolith façade. This quarter inch thick product is overlaid into concrete and does not fade, rust, or scratch. It has the look of Corten steel but at a fraction of the weight" - RMW President Russ Nichols



SAN LEANDRO TECH CAMPUS
SAN LEANDRO (USA)

Ventilated Façade:
Iron Corten & Chocolate, 6 mm+

Cladding System:
HC SYSTEM

Designed by:
RMV ARCHITECTURE & INTERIORS





GOLF ZONE PROJECT
DAEJEON (SOUTH KOREA)

Ventilated Façade:
Nieve Satin, 6 mm+

Cladding System:
HC SYSTEM

Designed by:
GANSAM

NORDSTROM MALL
OTTAWA (CANADA)

Ventilated Façade:
Barro Satin, Perla Satin & Arena Satin &
Polished 6 mm+

Cladding System:
CERAMITEX SYSTEM

Designed by:
CALLISON ARCHITECTS

NEOLITH
skyline.





NORDSTROM

Mackenzie King



NORDSTROM MALL
OTTAWA (CANADA)

Ventilated Façade:
Barro Satin, Perla Satin & Arena Satin &
Polished 6 mm+

Cladding System:
CERAMITEX SYSTEM

Designed by:
CALLISON ARCHITECTS







STRATHROY HOSPITAL
STRATHROY (CANADA)

Ventilated Façade:

Basalt Grey Satin &
Avorio Satin 6 mm+

Designed by:
NICHOLSON SHEFFIELD





STRATHROY HOSPITAL
STRATHROY (CANADA)

Ventilated Façade:

Basalt Grey Satin &
Avorio Satin 6 mm+

Designed by:
NICHOLSON SHEFFIELD

Produced by:

Thesize[®]
SURFACES

P.I. Camí Fondo, Supoi 8. C/ Íbers 31
12550 - Almassora (Spain)
+34 964 652 233
info@thesize.es
www.neolith.com

Marketed by:

NEOLITH[®]
DISTRIBUTION